

Teekay

the pipe coupling



two pipes... two screws... two minutes

www.teekaycouplings.com

Contents

Introducing the Teekay Pipe Coupling System.....	3
Mechanical and Sealing Concepts	4
Axilock-S and Axilock	6
Axilock-FP and Axilock-FP Ultra	10
Marine Application Guide	13
Torque Tables: Axilock-S, Axilock, Axilock-FP.....	14
Axiflex.....	15
Repair Clamp	20
Repair Coupling	21
Stepped Coupling	24
Reducer and Flanged Reducer.....	26
Flange Adaptor	27
Dismantling Joint.....	31
Square Coupling	34
Installation Guide	35
Build Quality.....	46
Terms and Conditions.....	47



The contents of this brochure give general information about the products we make. It is not intended to be a piping manual. Piping system design should only be undertaken by independent professionals or specialists.

Although we make reasonable efforts to update the information in our brochures, we make no representations warranties or guarantees, whether express or implied, that the content of this brochure is the most accurate, complete or up-to-date version and consequently to the fullest extent permitted by law, errors and omissions are excepted.

This brochure was originally written in the English language and, in the event of any conflict, inconsistency or discrepancy between the English language version and any translation the English language version shall apply.

Introducing the Teekay Pipe Coupling System



Teekay Pipe Couplings allow pipes to be joined without the need for flanging, grooving, threading or welding. By simply butting two pipes together and connecting with a Teekay Pipe Coupling, space, weight, time and cost savings are achieved with every installation.



Teekay Couplings have been sold for over three decades to more than 85 countries worldwide for civil, water, oil & gas, marine, building service, process, automotive and countless other industrial projects for pipes between 21 mm and 4200 mm in diameter.



Mechanical & Sealing Concepts

Teekay Couplings are available in two configurations, **Axilock** and **Axiflex**:

Teekay **Axilock** (axially restrained)

The Teekay Axilock has two metallic anchor rings that dig into the pipe wall when the coupling is installed. This prevents the two pipes from pushing apart under pressure or pulling away under end-load.

Teekay **Axiflex** (non axially restrained)

The Teekay Axiflex joins pipes that are already anchored. In this instance the pipeline forces do not have to be contained by the couplings. Therefore diameters up to 4 metres are possible with this design. The coupling can be placed over the pipe ends or supplied in a wrap-around version.

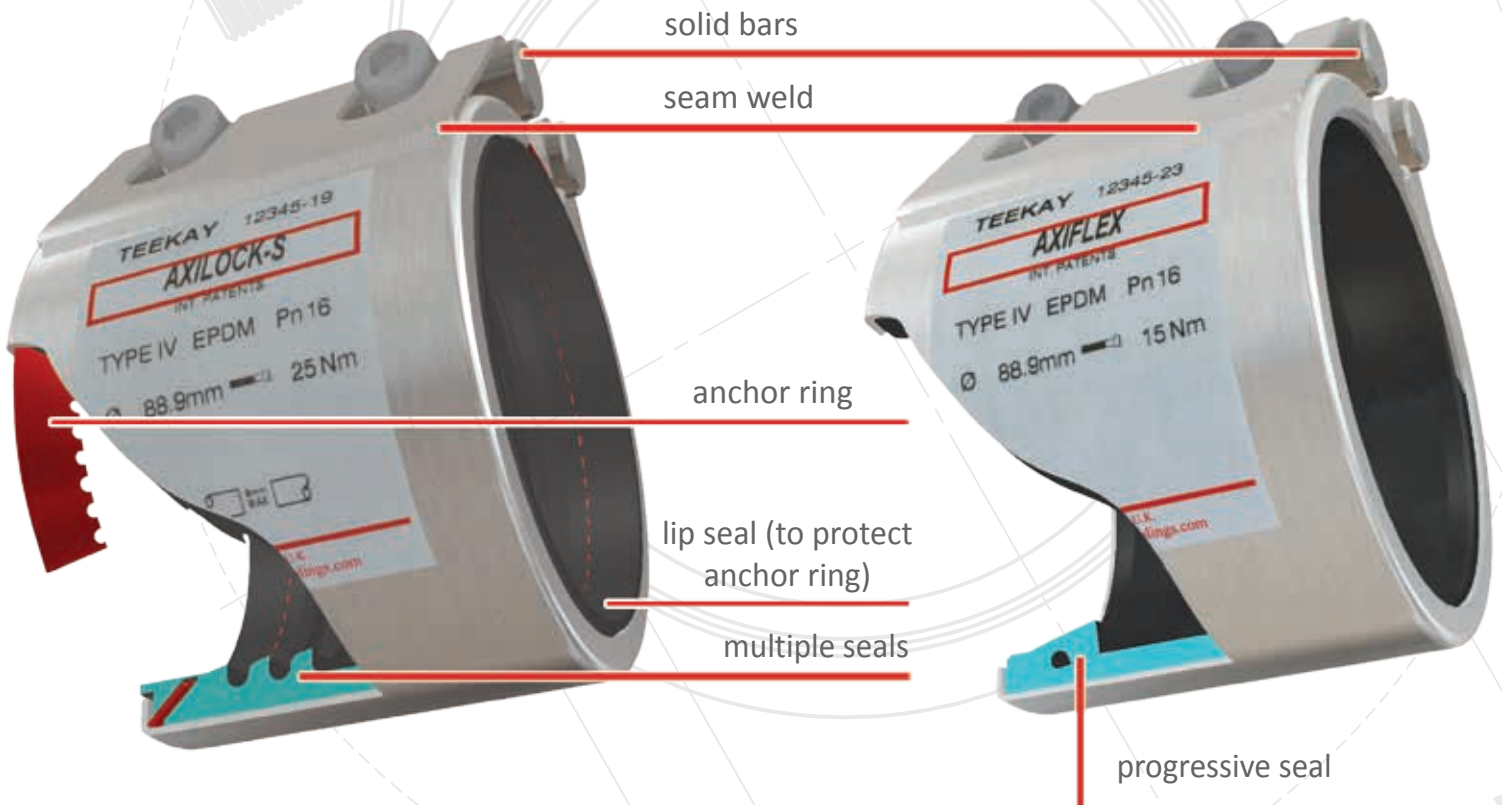

Each coupling (whether **Axilock** or **Axiflex**) consists of a casing, a gasket and a lockpart. The purpose of the casing is to house the gasket and to press it onto the pipe surface when the lockpart is closed. The lockpart is designed to pull the two ends of the casing together circumferentially around the pipe. In order to achieve this, the coupling is labelled clearly with a torque figure which ensures that the gasket is compressed sufficiently against the pipe surface.

The **Axilock** has two anchor rings which are placed adjacent to, but separate from, the sealing mechanism.

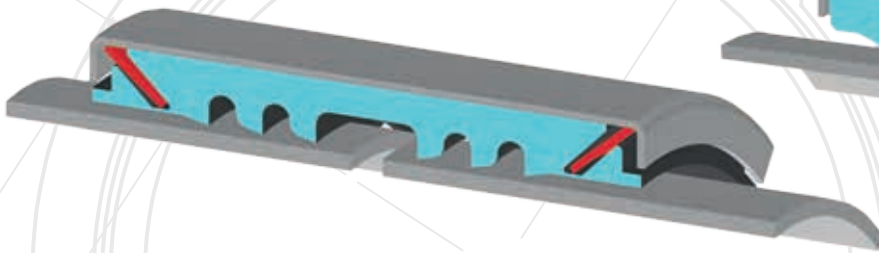

As the lockpart is tightened the sealing lips are pressed against the pipe surface to form a seal. At the same time the anchor rings penetrate the rubber, bite into the two pipes and prevent them from pulling apart, whether by external loading or internal pressure. The end seal is also pressed against the pipe surface, which protects both the anchor ring and the section of the pipe where the anchor rings have bitten, from any possible external corrosion.

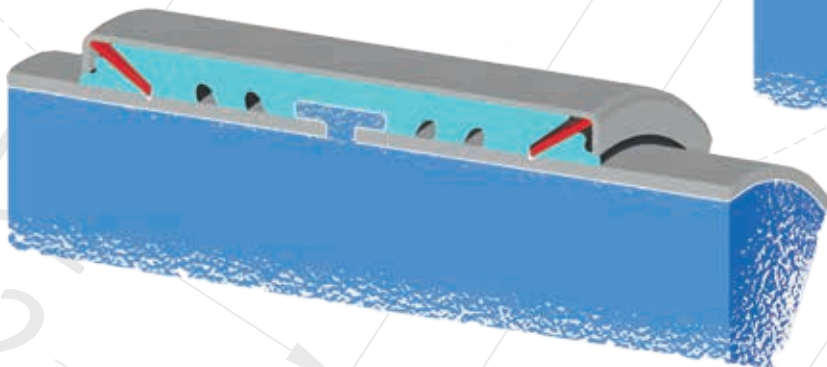

The **Axiflex** has two thick sealing lips which allow for pipe expansion and contraction.

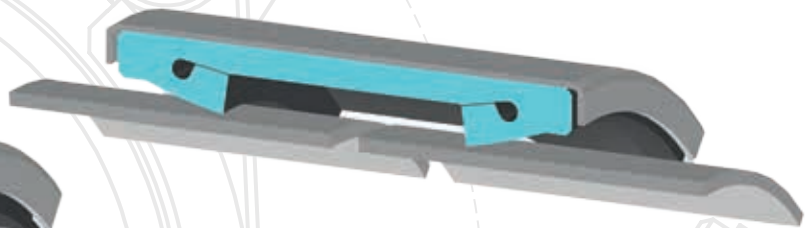

The sealing lips press against the pipe surface and form lip seals. The lip seals are designed to resist the internal pressure in the pipes. As the pressure increases, the lip seals swell to seal more tightly against the pipe surface.

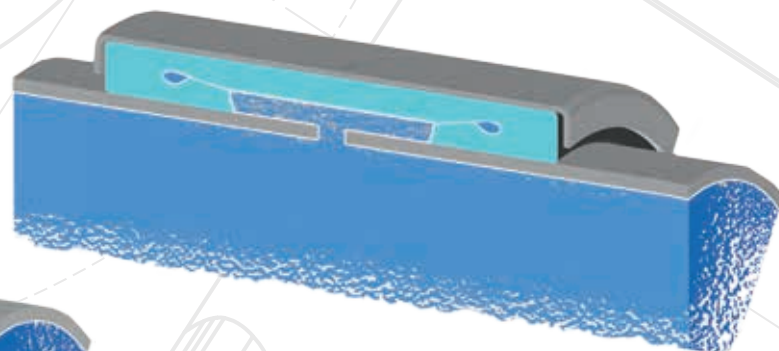

Axilock-S and Axilock



The Teekay Axilock range is designed to replace the need for flanging, welding, pipe grooving and pipe threading by providing a quick and easy solution to joining plain-end pipe. Incorporating grip rings at each end of the fitting, the Teekay Axilock offers high levels of security by locking the pipes together under pressure. Each coupling is 100% rubber-lined, ensuring that high levels of corrosion resistance are maintained throughout the life of the coupling.

Available in single (Axilock-S) and double (Axilock) casing versions depending on pressure and diameter.

Both models are suitable for new installations and retro-fit, whether on a ship, building or process plant. The Teekay Axilock range offers a versatile pipe coupling system that accommodates angulation, vibration and vacuum.

Material Selection

Type I

Casing: AISI 304 / DIN 1.4301
Fasteners: Alloy Steel, Coated
Gasket: EPDM/NBR/H-NBR/FKM/VMQ

Type II

Casing: AISI 304 / DIN 1.4301
Fasteners: AISI 316 / 316L
Gasket: EPDM/NBR/H-NBR/FKM/VMQ

Type IV

Casing: AISI 316L / DIN 1.4404
Fasteners: AISI 316 / 316L
Gasket: EPDM/NBR/H-NBR/FKM/VMQ

1.4462 Duplex casings and fasteners available on request.

Sizes: 21.3 mm to 711.0 mm

Gaskets: EPDM -40°C to +100°C, NBR -20°C to +80°C, HNBR -20°C to +130°C, Viton -20°C to +250°C, Silicone -70°C to +270°C (depending on grade)

Pipe Materials: Carbon steel, stainless steel, copper, cunifer, cast and ductile iron, GRP, most plastics & other materials (see page 36).



Axilock-S Dimensions

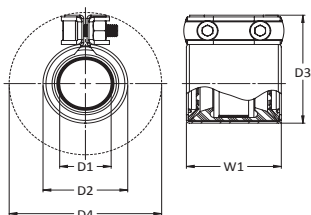

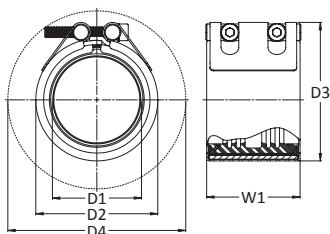

D1 Pipe O.D.	O.D. Tolerance	Working Pressure		Axial Pull	W1	D2	D3	D4	Screw Size	Hex Socket Adaptor	Weight	Box Qty
(mm)	(mm)	(bar)	(bar)	(N)	(mm)	(mm)	(mm)	(mm)		(mm)	KG	
21.3	21.0 / 21.6	16	42	5704	45	34	50	77	2 x M6	5	0.15	24
26.9	26.6 / 27.3	16	42	8528	45	39	56	83	2 x M6	5	0.16	24
28.0	27.7 / 28.4	16	42	8994	45	40	57	84	2 x M6	5	0.16	24
30.0	29.7 / 30.4	16	42	9900	45	42	59	86	2 x M6	5	0.17	24
33.7	33.3 / 34.1	16	42	11600	45	46	63	90	2 x M6	5	0.17	24
35.0	34.7 / 35.4	16	42	12031	45	47	64	91	2 x M6	5	0.18	24

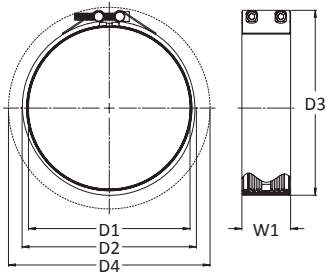

D1 Pipe O.D.	O.D. Tolerance	Working Pressure		Axial Pull	W1	D2	D3	D4	Screw Size	Hex Socket Adaptor	Weight	Box Qty
(mm)	(mm)	(bar)	(bar)	(N)	(mm)	(mm)	(mm)	(mm)		(mm)	KG	
38	37.0 / 39.0	16	42	14069	65	55	67	130	2 x M8	6	0.42	12
42.4	41.4 / 43.4	16	42	16950	65	60	71	132	2 x M8	6	0.43	12
44.5	43.5 / 45.5	16	42	18360	65	62	73	134	2 x M8	6	0.45	12
48.3	47.3 / 49.3	16	42	21263	65	66	77	136	2 x M8	6	0.47	12
54.0	53.0 / 55.0	16	42	25463	88	71	87	138	2 x M8	6	0.72	12
57.0	56.0 / 58.0	16	42	27570	88	74	90	140	2 x M8	6	0.85	12
60.3	59.0 / 62.0	16	42	30855	88	78	93	143	2 x M8	6	0.87	12
63.0	62.0 / 65.0	16	42	32432	88	80	96	145	2 x M8	6	0.90	12
67.0	66.0 / 69.0	16	42	35271	88	84	100	147	2 x M8	6	0.90	12
70.0	69.0 / 72.0	16	42	36575	88	87	103	150	2 x M8	6	0.91	12
73.0	72.0 / 75.0	16	42	35590	88	90	106	152	2 x M8	6	0.93	12
76.1	75.0 / 78.0	16	42	37312	88	94	109	185	2 x M10	8	0.95	12
82.5	81.5 / 84.5	16	42	43317	88	101	116	189	2 x M10	8	1.00	12
84.0	83.0 / 86.0	16	42	43627	88	102	118	190	2 x M10	8	1.02	12
88.9	88.0 / 91.0	16	42	44352	88	107	123	193	2 x M10	8	1.05	12
98.0	97.0 / 100.0	16	42	59613	88	116	132	200	2 x M10	8	1.25	12
101.6	100.5 / 103.5	16	42	63263	88	120	136	202	2 x M10	8	1.28	12
104.0	103.0 / 106.0	16	42	65779	88	122	138	204	2 x M10	8	1.31	12
108.0	107.0 / 110.0	16	42	69651	88	126	142	207	2 x M10	8	1.35	12
110.0	109.0 / 112.0	16	42	72254	88	128	144	208	2 x M10	8	1.41	12
114.3	113.0 / 116.0	16	42	76987	89	133	149	211	2 x M10	8	1.50	12
118.0	117.0 / 120.0	16	42	79864	89	137	154	214	2 x M10	8	1.58	5
127.0	126.0 / 129.0	16	42	87442	89	146	163	221	2 x M10	8	1.75	5
129.0	128.0 / 131.0	16	42	89562	89	148	165	223	2 x M10	8	1.85	5
133.0	132.0 / 135.0	16	42	94510	114	152	177	236	2 x M12	10	2.46	5
139.7	139.0 / 142.0	16	42	101205	114	159	184	241	2 x M12	10	2.65	5
141.3	140.5 / 143.5	13	34	101968	115	162	187	243	2 x M12	10	2.80	5
144.0	143.0 / 146.0	13	34	104272	115	164	190	245	2 x M12	10	2.90	4
154.0	153.0 / 156.0	13	34	112025	115	174	200	253	2 x M12	10	3.05	4
159.0	158.0 / 161.0	13	34	117195	115	179	205	257	2 x M12	10	3.15	4
165.0	164.0 / 167.0	13	34	124068	115	185	211	262	2 x M12	10	3.25	4
168.3	167.0 / 170.0	13	34	126855	115	189	214	265	2 x M12	10	3.40	4
170.0	169.0 / 172.0	13	34	129431	115	190	216	266	2 x M12	10	3.41	4

Axilock Dimensions



D1 Pipe O.D.	O.D. Tolerance	Working Pressure		Axial Pull (N)	W1 (mm)	D2 (mm)	D3 (mm)	D4 (mm)	Screw Size	Hex Socket Adaptor (mm)	Weight (KG)	Box Qty
		 (bar)	 (bar)									
141.3	140.5 / 143.5	16	42	100393	116	165	189	244	2 x M12	10	4.4	5
144.0	143.0 / 146.0	16	42	104266	116	167	192	246	2 x M12	10	4.4	4
154.0	153.0 / 156.0	16	42	119251	116	177	202	255	2 x M12	10	4.5	4
159.0	158.0 / 161.0	16	42	127120	118	184	210	287	2 x M16	14	4.6	4
165.0	164.0 / 167.0	16	42	136895	118	190	216	292	2 x M16	14	4.7	4
168.3	167.0 / 170.0	16	42	142425	118	194	219	294	2 x M16	14	4.8	4
170.0	169.0 / 172.0	16	42	145317	118	195	221	296	2 x M16	14	4.8	4
193.7	193.0 / 196.0	16	42	188860	119	220	246	315	2 x M16	14	6.5	2
219.1	218.0 / 221.0	16	42	241382	120	245	272	337	2 x M16	14	6.9	2
222.0	221.0 / 224.0	16	42	247814	120	248	275	339	2 x M16	14	6.9	2
244.5	243.5 / 246.5	8.75	23	164386	120	271	297	358	2 x M16	14	7.2	*
267.0	266.0 / 269.0	8.75	23	196033	120	293	320	378	2 x M16	14	7.5	*
273.0	272.0 / 275.0	8.75	23	204943	120	299	326	383	2 x M16	14	7.7	*
323.9	323.0 / 326.0	7.5	19	247276	120	350	377	429	2 x M16	14	9.5	*
326.0	325.0 / 328.0	7.5	19	250493	120	352	379	431	2 x M16	14	9.5	*
355.6	354.5 / 357.5	6.0	15	238437	120	382	409	458	2 x M16	14	10.25	*
378.0	377.0 / 380.0	6.0	15	269423	120	404	431	479	2 x M16	14	10.5	*
406.4	405.0 / 408.0	6.0	15	311428	120	433	460	506	2 x M16	14	12.0	*
429.0	428.0 / 431.0	5.0	15	289191	120	455	482	527	2 x M16	14	12.5	*
457.2	456.0 / 459.0		2.5	164230	120	485	512	554	2 x M16	14	13.3	*
508.0	507.0 / 510.0		2.5	202753	120	535	563	603	2 x M16	14	14.7	*
558.8	558.0 / 561.0		2.5	245331	120	586	613	652	2 x M16	14	16.2	*
609.6	608.5 / 611.5		1.5	175178	120	637	664	701	2 x M16	14	17.7	*
660.4	659.5 / 662.5		1.5	205591	120	688	715	750	2 x M16	14	19.2	*
711.0	710.0 / 713.0		1.5	238437	120	739	766	799	2 x M16	14	20.7	*

NOTES:

The above tables are guides to the most common sizes. Couplings to suit specific outside diameters not listed may be manufactured to order. Please contact us for further details.



Working pressure for marine applications. Minimum burst is 4 times working pressure. Figures are based on typical values for standard wall carbon steel pipe. For use on thin or soft pipe materials such as thin wall stainless, copper alloy or plastic (by way of example only) please check with us first.



Working pressure for industrial and land-based applications. Minimum burst is 1.5 times working pressure. Figures are based on typical values for standard wall carbon steel pipe. For use on thin or soft pipe materials such as thin wall stainless, copper alloy or plastic (by way of example only) please check with us first.

Applicable Standards: DIN 86128 Form G (axial restrained)
ASTM F1476 Type II, Class 2 (flexible and restrained)

Box Quantity: Where marked * the couplings are packed according to quantity ordered.

Axilock-S & Axilock Applications



Engine installations



Ship systems

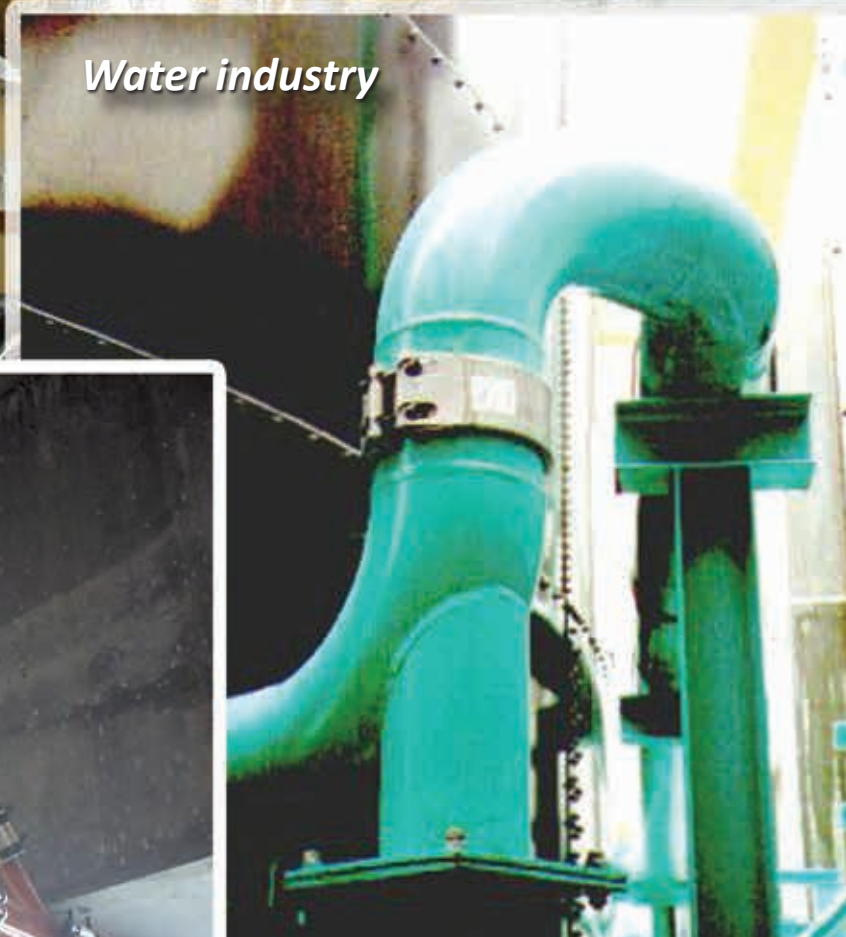

Water industry

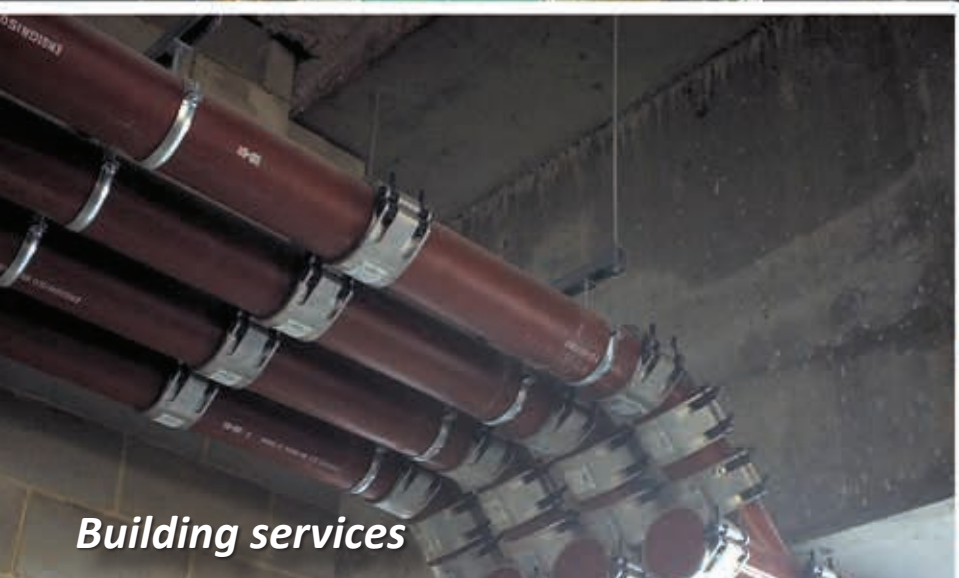

Building services

Axilock-FP and Axilock-FP Ultra

The Teekay Axilock-FP represents the ultimate in high security fire protected mechanical pipe couplings. With its unique internal fire sleeve and double casing design it is plain to see why this coupling is the primary pipe connection of choice in the marine and naval market sectors. The Axilock-FP has been tested to military standards for shock and fire resistance and is fully compliant with current IACS regulations.



Material Selection

Type I

Casing: AISI 304/ DIN 1.4301
Fasteners: Alloy Steel, Coated
Gasket: EPDM/NBR/H-NBR/FKM/VMQ

Type II

Casing: AISI 304/ DIN 1.4301
Fasteners: AISI 316/ 316L
Gasket: EPDM/NBR/H-NBR/FKM/VMQ

Type IV

Casing: AISI 316L/ DIN 1.4404
Fasteners: AISI 316/ 316L
Gasket: EPDM/NBR/H-NBR/FKM/VMQ

1.4462 Duplex casings and fasteners available on request.

Sizes: Axilock-FP: 21.3 mm to 219.1 mm Axilock-FP Ultra: 222.3 mm to 406.4 mm

Gaskets: EPDM -40°C to +100°C, NBR -20°C to +80°C, HNBR -20°C to +130°C, Viton -20°C to +250°C, Silicone -70°C to +270°C (depending on grade)

Pipe Materials: Carbon steel, stainless steel, copper, cunifer, GRE.



- Type Approved by all the major marine classification bodies.
- Internal fire sleeve. No external "wraps." (Patented design).
- Robust design. Resistant to shock, vibration and fire (to Naval standards).
- Compliant with current IACS regulations, including pressure pulsation, vibration and minimum burst requirements.
- Fire tested to ISO 19921/19922
- VdS certificated.

Axilock-FP Dimensions

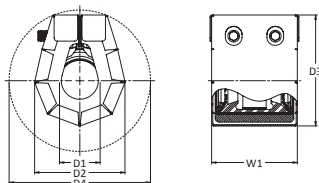

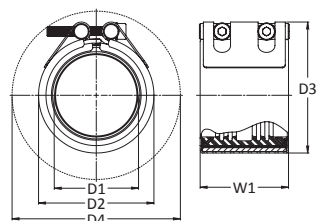

D1 Pipe O.D.	O.D. Tolerance	Working Pressure		Axial Pull	W1	D2	D3	D4	Screw Size	Hex Socket Adaptor	Weight	Box Qty
(mm)	(mm)	(bar)	(bar)	(N)	(mm)	(mm)	(mm)	(mm)		(mm)	KG	
21.3	21.0 / 21.6	16	42	2281	54	46	65	77	2 x M6	5	0.20	24
26.9	26.6 / 27.3	16	42	3638	54	52	70	80	2 x M6	5	0.25	24
28.0	27.7 / 28.4	16	42	3942	54	53	72	81	2 x M6	5	0.26	24
30.0	29.7 / 30.4	16	42	4525	54	55	74	82	2 x M6	5	0.26	24
33.7	33.3 / 34.1	16	42	5710	54	58	77	84	2 x M6	5	0.27	24
35.0	34.7 / 35.4	16	42	6160	54	60	79	85	2 x M6	5	0.28	24

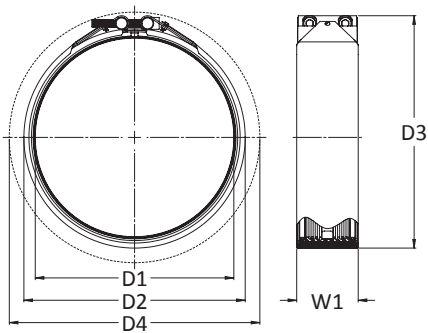

D1 Pipe O.D.	O.D. Tolerance	Working Pressure		Axial Pull	W1	D2	D3	D4	Screw Size	Hex Socket Adaptor	Weight	Box Qty
(mm)	(mm)	(bar)	(bar)	(N)	(mm)	(mm)	(mm)	(mm)		(mm)	KG	
38.0	37.0 / 39.0	16	42	7260	87	67	82	151	2 x M8	6	0.8	12
42.4	41.4 / 43.4	16	42	9040	87	71	86	154	2 x M8	6	0.9	12
44.5	43.5 / 45.5	16	42	9957	87	73	89	155	2 x M8	6	0.9	12
48.3	47.3 / 49.3	16	42	11730	87	77	92	157	2 x M8	6	1.0	12
54.0	53.0 / 55.0	16	42	14662	87	83	98	161	2 x M8	6	1.0	12
57.0	56.0 / 58.0	16	42	16337	87	86	101	163	2 x M8	6	1.0	12
60.3	59.0 / 62.0	16	42	18283	87	89	105	165	2 x M8	6	1.2	10
63.0	62.0 / 65.0	16	42	19957	87	92	108	167	2 x M8	6	1.2	10
67.0	66.0 / 69.0	16	42	22572	87	96	111	170	2 x M8	6	1.2	10
70.0	69.0 / 72.0	16	42	24639	87	100	116	172	2 x M8	6	1.2	10
73.0	72.0 / 75.0	16	42	26796	87	101	117	173	2 x M8	6	1.3	10
76.1	75.0 / 78.0	16	42	29120	88	104	123	188	2 x M10	8	1.3	10
82.5	81.5 / 84.5	16	42	34224	88	111	129	193	2 x M10	8	1.3	10
84.0	83.0 / 86.0	16	42	35749	88	112	131	194	2 x M10	8	1.3	10
88.9	88.0 / 91.0	16	42	39739	88	117	136	198	2 x M10	8	1.4	10
98.0	97.0 / 100.0	16	42	48291	88	125	144	206	2 x M10	8	1.8	10
101.6	100.5 / 103.5	16	42	51905	114	128	147	216	2 x M10	8	2.3	10
104.0	103.0 / 106.0	16	42	54386	114	131	149	218	2 x M10	8	2.3	10
108.0	107.0 / 110.0	16	42	58650	114	134	153	221	2 x M10	8	2.4	10
110.0	109.0 / 112.0	16	42	60842	114	136	156	223	2 x M10	8	2.5	10
114.3	113.0 / 116.0	16	42	65692	114	141	159	226	2 x M10	8	2.5	8
118.0	117.0 / 120.0	16	42	70014	114	145	163	230	2 x M10	8	2.6	8
127.0	126.0 / 129.0	16	42	81101	114	155	175	236	2 x M10	8	2.7	4
129.0	128.0 / 131.0	16	42	83675	114	157	177	238	2 x M12	10	3.8	4
133.0	132.0 / 135.0	16	42	88945	115	161	186	241	2 x M12	10	3.9	4
139.7	139.0 / 142.0	16	42	98132	115	168	193	247	2 x M12	10	4.0	4
141.3	140.5 / 143.5	16	42	100393	115	170	194	248	2 x M12	10	4.0	4
144.0	143.0 / 146.0	16	42	104266	115	173	197	251	2 x M12	10	4.0	4
154.0	153.0 / 156.0	16	42	119251	115	183	207	261	2 x M12	10	4.2	4
159.0	158.0 / 161.0	16	42	127120	117	189	215	291	2 x M16	14	5.0	4
165.0	164.0 / 167.0	16	42	136895	117	195	221	296	2 x M16	14	5.1	4
168.3	167.0 / 170.0	16	42	142425	117	199	224	298	2 x M16	14	5.2	4
170.0	169.0 / 172.0	16	42	145317	117	201	226	300	2 x M16	14	5.2	4
193.7	193.0 / 196.0	12	31	141495	120	225	251	319	2 x M16	14	6.5	2
219.1	218.0 / 221.0	12	31	181036	120	251	277	341	2 x M16	14	6.8	2

Axilock-FP Ultra Dimensions



D1 Pipe O.D.	O.D. Tolerance	Working Pressure		Axial Pull	W1	D2	D3	D4	Screw Size	Hex Socket Adaptor	Weight	Box Qty
		 (bar)	 (bar)									
(mm)	(mm)	(bar)	(bar)	(N)	(mm)	(mm)	(mm)	(mm)		(mm)	KG	
222.3	221.0 / 224.0	12	31	186363	124.5	264	287	344	2 x M16	14	8.0	*
244.5	243.5 / 246.5	8.75	23	164386	124.5	287	309	366	2 x M16	14	8.5	*
267.0	266.0 / 268.0	8.75	23	196033	124.5	309	330	387	2 x M16	14	9.0	*
273.0	272.0 / 275.0	7.5	19	175665	124.5	315	338	395	2 x M16	14	9.5	*
323.9	323.0 / 326.0	7.5	19	247276	124.5	366	389	446	2 x M16	14	10.0	*
326.0	325.0 / 328.0	6	15	200394	124.5	368	391	448	2 x M16	14	10.5	*
355.6	354.5 / 357.5	6	15	238437	124.5	397.5	421	478	2 x M16	14	11.0	*
378.0	377.0 / 380.0	6	15	269423	124.5	420	443	500	2 x M16	14	11.5	*
406.4	405.0 / 408.0	5	13	259324	124.5	448	471	528	2 x M16	14	12.0	*

NOTES:

The above tables are guides to the most common sizes. Couplings to suit specific outside diameters not listed may be manufactured to order. Please contact us for further details.



Working pressure for marine applications. Minimum burst is 4 times working pressure. Figures are based on typical values for standard wall carbon steel pipe. For use on thin or soft pipe materials such as thin wall stainless, copper alloy or plastic (by way of example only) please check with us first.



Working pressure for industrial and land-based applications. Minimum burst is 1.5 times working pressure. Figures are based on typical values for standard wall carbon steel pipe. For use on thin or soft pipe materials such as thin wall stainless, copper alloy or plastic (by way of example only) please check with us first.

Applicable Standards: DIN 86128 Form G (axial restrained)
ASTM F1476 Type II, Class 2 (flexible and restrained)

Box Quantity: Where marked * the couplings are packed according to quantity ordered.



For data values of VdS approved Axilock-FP couplings, please contact us.

Axilock-S or Axilock-FP

marine application guide



Marine applications guide to the use of Axilock-S / Axilock couplings and Axilock-FP / Axilock-FP Ultra

Ship System	Axilock-S & Axilock	Axilock-FP & Axilock-FP Ultra	Notes
Flammable Fluids (Flash Point ≤ 60°C)			
Cargo Oil Lines	✓	✓	Axilock-FP must be used in pump rooms and on open decks.
Crude Oil Washing Lines	✓	✓	Axilock-FP must be used in pump rooms and on open decks.
Vent Lines	x	✓	
Inert Gas			
Water Seal Effluent Lines	✓	✓	
Scrubber Effluent Lines	✓	✓	
Main Lines	✓	✓	Neither type permitted in Category A machinery spaces or accommodation spaces. Other machinery spaces may be acceptable providing couplings are in easily visible and accessible locations. Axilock-FP must be used in pump rooms and on open decks.
Distribution Lines	✓	✓	Axilock-FP must be used in pump rooms and on open decks.
Flammable Fluids (Flash Point > 60 °C)			
Cargo Oil Lines	✓	✓	Axilock-FP must be used in pump rooms and on open decks.
Fuel Oil Lines	x	✓	Only Axilock-FP permitted but not in Category A machinery spaces or accommodation spaces. Other machinery spaces may be acceptable providing couplings are in easily visible and accessible locations.
Lubricating Oil Lines	x	✓	Only Axilock-FP permitted but not in Category A machinery spaces or accommodation spaces. Other machinery spaces may be acceptable providing couplings are in easily visible and accessible locations.
Hydraulic Oil	x	✓	Only Axilock-FP permitted but not in Category A machinery spaces or accommodation spaces. Other machinery spaces may be acceptable providing couplings are in easily visible and accessible locations.
Thermal Oil	x	✓	Only Axilock-FP permitted but not in Category A machinery spaces or accommodation spaces. Other machinery spaces may be acceptable providing couplings are in easily visible and accessible locations.
Seawater			
Bilge Lines	✓	✓	Inside Category A machinery spaces only Axilock-FP is permitted (except LR – special rules apply).
Fire Main & Water Spray	x	✓	
Foam System	x	✓	
Sprinkler System	x	✓	
Ballast System	✓	✓	Inside Category A machinery spaces only Axilock-FP is permitted.
Cooling Water System	✓	✓	Inside Category A machinery spaces only Axilock-FP is permitted.
Tank Cleaning Services	✓	✓	
Non-Essential Systems	✓	✓	
Fresh Water			
Cooling Water Systems	✓	✓	Inside Category A machinery spaces only Axilock-FP is permitted.
Condensate Return	✓	✓	Inside Category A machinery spaces only Axilock-FP is permitted.
Non-Essential System	✓	✓	
Sanitary / Drains / Scuppers			
Deck Drains (Internal)	✓	✓	Use of couplings allowed only above freeboard deck.
Sanitary Drains	✓	✓	
Sounding / Vent			
Water Tanks / Dry Spaces	✓	✓	
Oil Tanks (flash point > 60 °C)	x	✓	Only Axilock-FP permitted but not in Category A machinery spaces or accommodation spaces. Other machinery spaces may be acceptable providing couplings are in easily visible and accessible locations.
Miscellaneous			
Service Air (Non-Essential)	✓	✓	
Brine	✓	✓	
Steam	✓	✓	Couplings must be restrained on the pipes and may be used on deck with a design pressure of 10 bar or less.

The above table is for guidance only. For full details and more information on allowances and limitations on marine installations see IACS UR P2 Table 7, available as a download from www.iacs.org.uk or from the individual classification societies.

Torque Tables

Please consult the table below for torque ratings on Axilock-S, Axilock and Axilock-FP couplings. All couplings have the torque rating printed on the label. Torques are based on standard pipe properties. Torques may be adjusted up or down according to wall thickness and/or material hardness.

D1 Pipe O.D.	Axilock-S Torque (NM)			Axilock Torque (NM)			Axilock-FP Torque (NM)			
	Steel	Stainless Steel	CuNi	Steel	Stainless Steel	CuNi	Steel	Stainless Steel	CuNi	Vds
21.3	8	8	8				8	8	8	
26.9	8	8	8				8	8	8	
28.0	8	8	8				8	8	8	
30.0	8	8	8				8	8	8	
33.7	8	8	8				8	8	8	
35.0	8	8	8				8	8	8	
38.0	15	15	10				15	15	10	30
42.4	15	15	10				15	15	10	
44.5	15	15	10				15	15	10	
48.3	15	15	10				15	15	10	30
54.0	15	15	10				15	15	10	
57.0	15	15	10				15	15	10	
60.3	15	15	15				20	20	20	30
63.0	15	15	15				20	20	20	
67.0	15	15	15				20	20	20	
70.0	15	15	15				20	20	20	
73.0	15	15	15				20	20	20	
76.1	20	20	20				30	30	25	30
82.5	20	20	20				30	30	25	
84.0	20	20	20				30	30	25	
88.9	20	20	20				30	30	25	45
98.0	25	25	25				30	30	25	
101.6	25	25	25				45	45	30	
104.0	25	25	25				45	45	30	
108.0	25	25	25				45	45	30	80
110.0	25	25	25				45	45	30	
114.3	30	30	30				45	45	30	80
118.0	30	30	30				45	45	30	
127.0	30	30	30				45	45	30	
129.0	30	30	30				65	65	30	
133.0	35	35	35				65	65	35	120
139.7	35	35	35				65	65	35	120
141.3	35	35	35	65	65	35	65	65	35	
144.0	35	35	35	65	65	35	65	65	35	
154.0	50	50	35	65	65	35	65	65	35	
159.0	50	50	35	85	85	35	85	85	35	150
165.0	50	50	35	85	85	35	85	85	35	
168.3	50	50	35	85	85	35	85	85	35	150
170.0	50	50	35	85	85	35	85	85	35	
193.7				90	90	50	90	90	50	
219.1				100	100	50	100	100	50	
222.0				100	100	65				
244.5				100	100	65				
267.0				100	100	65				
273.0				110	110	65				
323.9				110	110	65				
326.0				110	110	65				
355.6				120	120	65				
378.0				120	120	65				
406.4				140	140	65				



The Teekay Axiflex is a high performance coupling that allows generous pipe angulation and expansion/contraction. The Axiflex is a popular choice of coupling with water authorities, civil engineers and building contractors and is available in sizes up to 4.2m in diameter.

The stainless steel and high strength steel designs ensure significant weight savings are achieved over cast iron couplings. The result is less manpower, quicker installation times and massive cost savings.

Material Selection

Type I

Casing: AISI 304/ DIN 1.4301
Fasteners: Alloy Steel, Coated
Gasket: EPDM/NBR/H-NBR/FKM/VMQ

Type II

Casing: AISI 304/ DIN 1.4301
Fasteners: AISI 316/ 316L
Gasket: EPDM/NBR/H-NBR/FKM/VMQ

Type IV

Casing: AISI 316L/ DIN 1.4404
Fasteners: AISI 316/ 316L
Gasket: EPDM/NBR/H-NBR/FKM/VMQ

Type V

Casing: High strength steel
Coating: Rilsan/PVC/
Epoxy/Galvanized
Fasteners: Alloy Steel, Coated
Gasket: EPDM/NBR/H-NBR/FKM/VMQ

Type VI

Casing: High strength steel
Coating: Rilsan/PVC/
Epoxy/Galvanized
Fasteners: AISI 316/ 316L
Gasket: EPDM/NBR/H-NBR/FKM/VMQ



Sizes: 21.3 mm to 4200.0 mm

Gaskets: EPDM -40°C to +100°C, NBR -20°C to +80°C, HNBR -20°C to +130°C, Viton -20°C to +250°C, Silicone -70°C to +270°C (depending on grade)

Pipe Materials: Carbon steel, cast and ductile iron, stainless steel, copper, cupifer, GRP, asbestos cement, HDPE, MDPE, PVC, uPVC, ABS

1.4462 Duplex casings and fasteners available on request.

Axiflex Dimensions

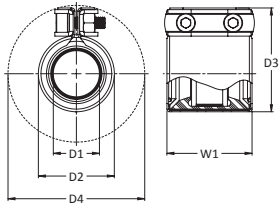

45 mm wide

D1 Pipe O.D.	O.D. Tolerance	Working Pressure Available in the following PN ratings:	W1	D2	D3	D4	Screw Size	Hex Socket Adaptor	Weight
(mm)	(mm)		(mm)	(mm)	(mm)	(mm)		(mm)	KG
21.3	21.0 / 21.6	16 / 25 / 40	45	34	50	77	2 x M6	5	0.15
26.9	26.6 / 27.3	16 / 25 / 40	45	39	56	83	2 x M6	5	0.16
28.0	27.7 / 28.4	16 / 25 / 40	45	41	57	84	2 x M6	5	0.16
30.0	29.7 / 30.4	16 / 25 / 40	45	42	59	86	2 x M6	5	0.17
33.7	33.3 / 34.1	16 / 25 / 40	45	46	63	90	2 x M6	5	0.17
35.0	34.7 / 35.4	16 / 25 / 40	45	48	64	91	2 x M6	5	0.18

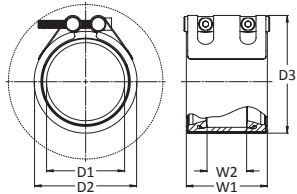

65 mm wide

D1 Pipe O.D.	O.D. Tolerance	Working Pressure Available in the following PN ratings:	W1	W2	D2	D3	Screw Size	Hex Socket Adaptor	Weight
(mm)	(mm)		(mm)	(mm)	(mm)	(mm)		(mm)	KG
38.0	37.0 / 39.0	16 / 25 / 40	65	10	57	70	2 x M8	6	0.4
42.4	41.4 / 43.4	16 / 25 / 40	65	10	63	75	2 x M8	6	0.4
44.5	43.5 / 45.5	16 / 25 / 40	65	10	65	77	2 x M8	6	0.4

85 mm wide

D1 Pipe O.D.	O.D. Tolerance	Working Pressure Available in the following PN ratings:	W1	W2	D2	D3	Screw Size	Hex Socket Adaptor	Weight
(mm)	(mm)		(mm)	(mm)	(mm)	(mm)		(mm)	KG
48.3	47.0 / 50.0	16 / 25 / 40	85	42	70	87	2 x M8	6	1.0
54.0	52.5 / 55.5	16 / 25 / 40	85	42	74	93	2 x M8	6	1.0
57.0	55.5 / 58.5	16 / 25 / 40	85	42	77	96	2 x M8	6	1.1
60.3	59.0 / 62.0	16 / 25 / 40	85	42	80	99	2 x M8	6	1.1
63.0	62.0 / 65.0	16 / 25 / 40	85	42	83	102	2 x M8	6	1.1
67.0	65.5 / 68.5	16 / 25 / 40	85	42	87	106	2 x M8	6	1.2
70.0	68.5 / 71.5	16 / 25 / 40	85	42	90	109	2 x M8	6	1.2
73.0	71.5 / 74.5	16 / 25 / 40	85	42	93	112	2 x M8	6	1.3
76.1	74.0 / 78.0	16 / 25 / 40	85	42	96	115	2 x M8	6	1.3
82.5	80.5 / 84.5	16 / 25 / 40	85	42	103	122	2 x M8	6	1.4
84.0	82.0 / 86.0	16 / 25 / 40	85	42	104	123	2 x M8	6	1.4
88.9	87.0 / 91.0	16 / 25 / 40	85	42	109	128	2 x M8	6	1.5
98.0	96.0 / 100.0	16 / 25 / 40	85	42	118	137	2 x M8	6	1.5
101.6	100.0 / 104.0	16 / 25 / 40	85	42	122	141	2 x M8	6	1.6
104.0	102.0 / 106.0	16 / 25 / 40	85	42	124	143	2 x M8	6	1.6
108.0	106.0 / 110.0	16 / 25 / 40	85	42	128	147	2 x M8	6	1.6
110.0	108.0 / 112.0	16 / 25 / 40	85	42	130	149	2 x M8	6	1.6
114.3	112.0 / 116.0	16 / 25 / 40	85	42	134	153	2 x M8	6	1.6
118.0	116.0 / 120.0	16 / 25 / 40	85	42	138	157	2 x M8	6	1.7

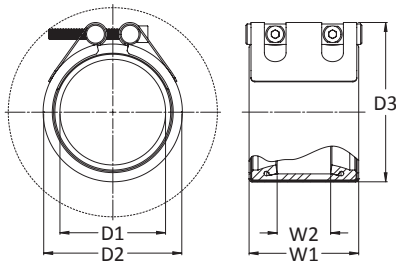

110 mm wide

D1 Pipe O.D.	O.D. Tolerance	Working Pressure Available in the following PN ratings:	W1	W2	D2	D3	Screw Size	Hex Socket Adaptor	Weight
(mm)	(mm)		(mm)	(mm)	(mm)	(mm)		(mm)	KG
88.9	87.0 / 91.0	16 / 25 / 40	110	67	111	133	2 x M10	8	2.0
98.0	96.0 / 100.0	16 / 25 / 40	110	67	120	142	2 x M10	8	2.0
101.6	100.0 / 104.0	16 / 25 / 40	110	67	124	146	2 x M10	8	2.0
104.0	102.0 / 106.0	16 / 25 / 40	110	67	126	148	2 x M10	8	2.0
108.0	106.0 / 110.0	16 / 25 / 40	110	67	130	152	2 x M10	8	2.0
110.0	108.0 / 112.0	16 / 25 / 40	110	67	132	154	2 x M10	8	2.0
114.3	112.0 / 116.0	16 / 25 / 40	110	67	136	158	2 x M10	8	2.0
118.0	116.0 / 120.0	16 / 25 / 40	110	67	140	162	2 x M10	8	2.0
127.0	125.0 / 129.0	16 / 25 / 40	110	67	149	171	2 x M10	8	2.2
129.0	127.0 / 131.0	16 / 25 / 40	110	67	151	173	2 x M10	8	2.2
133.0	131.0 / 135.0	16 / 25 / 40	110	67	155	177	2 x M10	8	2.3
139.7	138.0 / 142.0	16 / 25 / 40	110	67	162	184	2 x M10	8	2.3
141.3	139.0 / 143.0	16 / 25 / 40	110	67	163	186	2 x M10	8	2.3
144.0	142.0 / 146.0	16 / 25 / 40	110	67	166	188	2 x M10	8	2.3
154.0	151.0 / 156.0	16	110	67	176	198	2 x M10	8	2.4
159.0	156.0 / 161.0	16	110	67	181	203	2 x M10	8	2.5
165.0	162.0 / 167.0	16	110	67	187	209	2 x M10	8	2.5
168.3	165.0 / 170.0	16	110	67	190	212	2 x M10	8	2.5
170.0	167.0 / 172.0	16	110	67	192	214	2 x M10	8	2.5
193.7	191.0 / 197.0	16	110	67	216	238	2 x M10	8	2.8
219.1	216.0 / 222.0	16	110	67	242	263	2 x M10	8	3.2
222.0	218.0 / 224.0	16	110	67	244	266	2 x M10	8	3.2
244.5	241.0 / 247.0	16	110	67	267	289	2 x M10	8	3.3
267.0	264.0 / 270.0	16	110	67	289	311	2 x M10	8	3.5
273.0	270.0 / 276.0	16	110	67	295	317	2 x M10	8	3.5
323.9	321.0 / 327.0	10	110	67	346	368	2 x M10	8	3.8
326.0	322.0 / 328.0	10	110	67	348	370	2 x M10	8	3.8

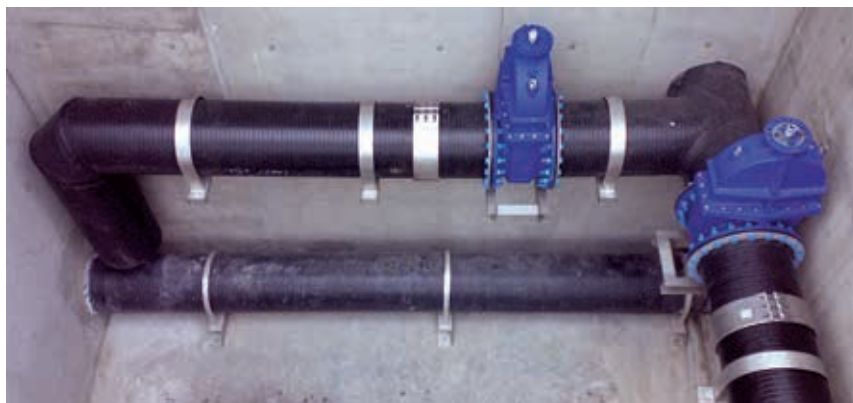

Axiflex Dimensions

140 mm, 210 mm, 310 mm, 410 mm wide

D1 Pipe O.D.	Pipe Nominal Bore	Available Coupling Widths:				Working Pressure Available in the following PN ratings:	W2	D2 Coupling O.D. = D1 (mm) + the following:
		(mm)	140 mm	210 mm	310 mm			
Teekay Axiflex couplings are available to suit any pipe O.D. up to 4200 mm. Please contact us with OD prior to order placement.	150	●				16 / 25 / 40	80	22
	200	●	●			16 / 25 / 40	80 / 120	22 / 42
	250	●	●			16 / 25 / 40	80 / 120	22 / 42
	300	●	●	●	●	16 / 25 / 40	80 / 120 / 220 / 320	28 / 42 / 42 / 42
	350	●	●	●	●	16 / 25 / 40	80 / 120 / 220 / 320	28 / 42 / 42 / 42
	400	●	●	●	●	10 / 16 / 25	80 / 120 / 220 / 320	28 / 42 / 42 / 42
	450	●	●	●	●	10 / 16 / 25	80 / 120 / 220 / 320	28 / 42 / 42 / 42
	500	●	●	●	●	10 / 16 / 25	80 / 120 / 220 / 320	28 / 42 / 42 / 42
	600	●	●	●	●	10 / 16 / 25	80 / 120 / 220 / 320	28 / 42 / 42 / 42
	700	●	●	●	●	10 / 16 / 25	80 / 120 / 220 / 320	28 / 42 / 42 / 42
	800	●	●	●	●	10 / 16 / 25	80 / 120 / 220 / 320	28 / 42 / 42 / 42
	900	●	●	●	●	6 / 10 / 16	80 / 120 / 220 / 320	28 / 42 / 42 / 42
	1000	●	●	●	●	6 / 10 / 16	80 / 120 / 220 / 320	28 / 42 / 42 / 42
	1100	●	●	●	●	6 / 10 / 16	80 / 120 / 220 / 320	28 / 42 / 42 / 42
	1200	●	●	●	●	6 / 10 / 16	80 / 120 / 220 / 320	28 / 42 / 42 / 42
	1300		●	●	●	6 / 10 / 16	120 / 220 / 320	42 / 42 / 42
	1400		●	●	●	6 / 10 / 16	120 / 220 / 320	42 / 42 / 42
	1500		●	●	●	2.5 / 6 / 10	120 / 220 / 320	42 / 42 / 42
	1600		●	●	●	2.5 / 6 / 10	120 / 220 / 320	42 / 42 / 42
	1700		●	●	●	2.5 / 6 / 10	120 / 220 / 320	42 / 42 / 42
	1800		●	●	●	2.5 / 6 / 10	120 / 220 / 320	42 / 42 / 42
	1900		●	●	●	2.5 / 6 / 10	120 / 220 / 320	42 / 42 / 42
	2000		●	●	●	2.5 / 6 / 10	120 / 220 / 320	42 / 42 / 42
	2100		●	●	●	2.5 / 6	120 / 220 / 320	102 / 102 / 102
	2200		●	●	●	2.5 / 6	120 / 220 / 320	102 / 102 / 102
	2300		●	●	●	2.5 / 6	120 / 220 / 320	102 / 102 / 102
	2400		●	●	●	2.5 / 6	120 / 220 / 320	102 / 102 / 102
	2500		●	●	●	2.5 / 6	120 / 220 / 320	102 / 102 / 102
	2600		●	●	●	2.5 / 6	120 / 220 / 320	102 / 102 / 102
	2700		●	●	●	2.5 / 5	120 / 220 / 320	102 / 102 / 102
	2800		●	●	●	2.5 / 5	120 / 220 / 320	102 / 102 / 102
	2900		●	●	●	2.5 / 5	120 / 220 / 320	102 / 102 / 102
3000		●	●	●	2.5 / 5	120 / 220 / 320	102 / 102 / 102	
3200		●	●	●	2.5 / 5	120 / 220 / 320	102 / 102 / 102	
3400		●	●	●	2.5 / 4	120 / 220 / 320	102 / 102 / 102	
3600		●	●	●	2.5 / 4	120 / 220 / 320	102 / 102 / 102	
3800		●	●	●	2.5 / 4	120 / 220 / 320	102 / 102 / 102	
4000		●	●	●	2.5 / 4	120 / 220 / 320	102 / 102 / 102	
4200		●	●	●	2.5	120 / 220 / 320	102 / 102 / 102	

NOTES: The above tables are guides to the most common sizes. Couplings to suit specific outside diameters not listed may be manufactured to order. Please contact us for further details. Minimum burst is 1.5 times working pressure. Figures are based on typical values for standard wall carbon steel pipe. For use on thin or soft pipe materials such as thin wall stainless, copper alloy or plastic (by way of example only) please check with us first.

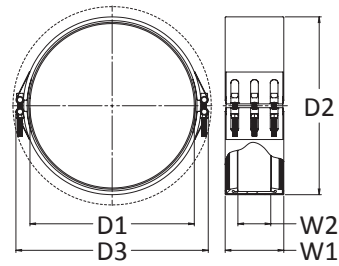
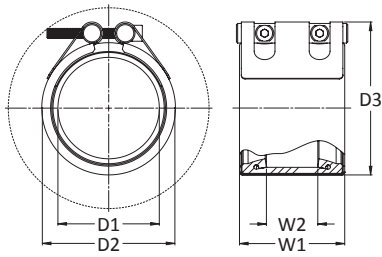

D3 Overall Coupling O.D. = D1 (mm) + the following:	Number of Screws	Approximate Weight	Maximal Allowable Tolerance on Pipe O.D. +/-	Pipe Nominal Bore	D1 Pipe O.D.
(mm)		(KG)	(mm)	(mm)	
44	2	4.0	2.5	150	
44 / 72	2 / 2 / 3	4.5 / 7.9	3 / 3	200	
44 / 72	2 / 2 / 3	5.0 / 8.6	3 / 3	250	
58 / 72 / 72 / 72	2 / 2 / 3 / 4 / 6	6.0 / 9.7 / 17.3 / 22	4 / 5 / 5 / 5	300	
58 / 72 / 72 / 72	2 / 2 / 3 / 4 / 6	7.1 / 10.7 / 18.4 / 24	4 / 5 / 5 / 5	350	
58 / 72 / 72 / 72	2 / 2 / 3 / 4 / 6	8.0 / 12.9 / 20.1 / 26	4 / 5 / 5 / 5	400	
58 / 72 / 72 / 72	2 / 2 / 3 / 4 / 6	9.0 / 14.0 / 21.8 / 29	4 / 5 / 5 / 5	450	
58 / 72 / 72 / 72	2 / 2 / 3 / 4 / 6	9.5 / 16.1 / 26.6 / 32	4 / 5 / 5 / 5	500	
58 / 72 / 72 / 72	2 / 2 / 3 / 4 / 6	11.0 / 17.3 / 30.5 / 39	4 / 6 / 6 / 6	600	
58 / 72 / 72 / 72	2 / 3 / 4 / 6	12.5 / 22.5 / 34.4 / 44	4 / 6 / 6 / 6	700	
58 / 72 / 72 / 72	2 / 3 / 4 / 6	14.4 / 25.1 / 38.4 / 49	4 / 6 / 6 / 6	800	
58 / 72 / 72 / 72	2 / 3 / 4 / 6	15.8 / 27.6 / 42.3 / 55	4 / 6 / 6 / 6	900	
58 / 72 / 72 / 72	2 / 3 / 4 / 6	16.8 / 30.2 / 46.2 / 60	4 / 6 / 6 / 6	1000	
58 / 72 / 72 / 72	2 / 3 / 4 / 6	18.0 / 38.3 / 50.1 / 65	4 / 6 / 6 / 6	1100	
58 / 72 / 72 / 72	2 / 3 / 4 / 6	19.5 / 41.3 / 54.0 / 70	4 / 6 / 6 / 6	1200	
102 / 102 / 102	6 / 8 / 12	47.7 / 63.9 / 83	10 / 10 / 10	1300	
102 / 102 / 102	6 / 8 / 12	50.5 / 67.9 / 88	10 / 10 / 10	1400	
102 / 102 / 102	6 / 8 / 12	53.2 / 71.8 / 93	10 / 10 / 10	1500	
102 / 102 / 102	6 / 8 / 12	56.5 / 75.7 / 98	10 / 10 / 10	1600	
102 / 102 / 102	6 / 8 / 12	59.8 / 79.6 / 103	10 / 10 / 10	1700	
102 / 102 / 102	6 / 8 / 12	62.3 / 83.5 / 108	10 / 10 / 10	1800	
102 / 102 / 102	12 / 16 / 24	64.0 / 85.0 / 113	10 / 10 / 10	1900	
102 / 102 / 102	12 / 16 / 24	65.2 / 87.5 / 118	10 / 10 / 10	2000	
102 / 102 / 102	12 / 16 / 24	68.1 / 91.4 / 138	10 / 10 / 20	2100	
102 / 102 / 102	12 / 16 / 24	70.9 / 95.3 / 144	10 / 10 / 20	2200	
102 / 102 / 102	12 / 16 / 24	73.9 / 99.2 / 148	10 / 10 / 20	2300	
102 / 102 / 102	12 / 16 / 24	75.9 / 103.1 / 153	10 / 10 / 20	2400	
102 / 102 / 102	12 / 16 / 24	79.8 / 118.4 / 156	10 / 10 / 20	2500	
102 / 102 / 102	12 / 16 / 24	87.5 / 122.3 / 164	10 / 10 / 20	2600	
102 / 102 / 102	12 / 16 / 24	92.9 / 126.3 / 169	10 / 10 / 20	2700	
102 / 102 / 102	12 / 16 / 24	96.2 / 130.2 / 174	10 / 10 / 20	2800	
102 / 102 / 102	12 / 16 / 24	98.7 / 134.1 / 179	10 / 10 / 20	2900	
102 / 102 / 102	12 / 16 / 24	109.6 / 138.0 / 185	10 / 10 / 20	3000	
102 / 102 / 102	12 / 16 / 24	128 / 164 / 204	10 / 20 / 20	3200	
102 / 102 / 102	12 / 16 / 24	135 / 172 / 216	10 / 20 / 20	3400	
102 / 102 / 102	18 / 24 / 36	148 / 191 / 236	10 / 20 / 20	3600	
102 / 102 / 102	18 / 24 / 36	153 / 200 / 244	10 / 20 / 20	3800	
102 / 102 / 102	18 / 24 / 36	159 / 207 / 254	10 / 20 / 20	4000	
102 / 102 / 102	18 / 24 / 36	166 / 216 / 265	10 / 20 / 20	4200	

Teekay Afflix couplings are available to suit any pipe O.D. up to 4200 mm. Please contact us with OD prior to order placement.

Applicable Standards: DIN 86128 Form F (non axial restrained)
 ASTM F1476 Type II, Class 3 (flexible and unrestrained)

Repair Clamp



The Teekay Repair Clamp is the budget repair coupling of choice. Featuring “cut flanges” on the underside of the fitting, this type of coupling can be easily pulled around a leaking pipe to seal a fracture. Once wrapped around the pipe, the fitter then goes about installing the coupling in the same manner as any other Teekay coupling.

Suitable for emergency repairs in buildings and industrial units to avoid costly reinstatement work caused by water damage. The Teekay Repair Clamp represents excellent value for money both at point of order and at point of use, as significant installation time savings can be achieved with the light-weight stainless steel design.

Material Selection

Type I

Casing: AISI 304/ DIN 1.4301
Fasteners: Alloy Steel, Coated
Gasket: EPDM/NBR/H-NBR/FKM/VMQ

Type II

Casing: AISI 304/ DIN 1.4301
Fasteners: AISI 316/ 316L
Gasket: EPDM/NBR/H-NBR/FKM/VMQ

Type IV

Casing: AISI 316L/ DIN 1.4404
Fasteners: AISI 316/ 316L
Gasket: EPDM/NBR/H-NBR/FKM/VMQ

1.4462 Duplex casings and fasteners available on request.

- Sizes:** 48.3 mm to 323.9 mm
- Gaskets:** EPDM -40°C to +100°C, NBR -20°C to +80°C, HNBR -20°C to +130°C, Viton -20°C to +250°C, Silicone -70°C to +270°C (*depending on grade*)
- Pipe Materials:** Carbon steel, cast and ductile iron, stainless steel, copper, cunifer, GRP, asbestos cement, HDPE, MDPE, PVC, uPVC, ABS

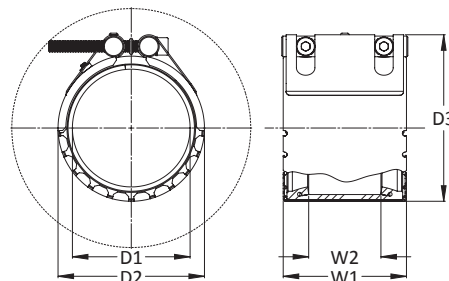

NOTES:

The table below is a guide to the most common sizes. Couplings to suit specific outside diameters not listed may be manufactured to order. Please contact us for further details.

Minimum burst is 1.5 times working pressure. Figures are based on typical values for standard wall carbon steel pipe. For use on thin or soft pipe materials such as thin wall stainless, copper alloy or plastic (by way of example only) please check with us first.

D1 Pipe O.D.	Pipe Nominal Bore		W1	W2	D2 Coupling O.D. = D1 (mm) + the following:	D3 Overall Coupling O.D. = D1 (mm) + the following:	No. of Screws	Approxi- mate Weight	Maximum Allowable Tolerance on Pipe O.D. +/-
	(mm)	(bar)							
Teekay Repair Clamps are available to suit any pipe O.D. from 48.3 mm up to 323.9 mm. Please contact us with O.D. prior to order placement.	40	16	85	42	20	39	2 x M8	1	1
	50	16	85	42	20	39	2 x M8	1.1	1
	65	16	85	42	20	39	2 x M8	1.3	1
	80	16	85	42	20	39	2 x M8	1.5	1
	100	16	85	42	20	39	2 x M8	1.6	1
	150	16	110	67	22	44	2 x M10	2.5	2
	200	12	110	67	22	44	2 x M10	3.2	2
	250	6	110	67	22	44	2 x M10	3.5	2
	300	6	110	67	22	44	2 x M10	3.8	2



The Teekay Repair Coupling is ideal for all situations where you need to make a permanent repair under pressure. Simply open up the coupling, wrap it around the pipe and fasten – you have repaired the pipeline in minutes and avoided the need for costly downtime.

The Repair Coupling comes with no loose parts and features our standard gasket which actively seals onto the pipe. The range is available up to 3000 mm OD and in widths up to 410 mm wide. The Teekay Repair Coupling is used throughout the water, process, oil & gas and marine industries.

Material Selection

Type I

Casing: AISI 304/ DIN 1.4301
Fasteners: Alloy Steel, Coated
Gasket: EPDM/NBR/H-NBR/FKM/VMQ

Type II

Casing: AISI 304/ DIN 1.4301
Fasteners: AISI 316/ 316L
Gasket: EPDM/NBR/H-NBR/FKM/VMQ

Type IV

Casing: AISI 316L/ DIN 1.4404
Fasteners: AISI 316/ 316L
Gasket: EPDM/NBR/H-NBR/FKM/VMQ

Type V

Casing: High strength steel
Coating: Rilsan/PVC/
Epoxy/Galvanized
Fasteners: Alloy Steel, Coated
Gasket: EPDM/NBR/H-NBR/FKM/VMQ

Type VI

Casing: High strength steel
Coating: Rilsan/PVC/
Epoxy/Galvanized
Fasteners: AISI 316/ 316L
Gasket: EPDM/NBR/H-NBR/FKM/VMQ



Sizes: 48.3 mm to 3000.0 mm
Gaskets: EPDM -40°C to +100°C, NBR -20°C to +80°C, HNBR -20°C to +130°C, Viton -20°C to +250°C, Silicone -70°C to +270°C (*depending on grade*)
Pipe Materials: Carbon steel, cast and ductile iron, stainless steel, copper, cunifer, GRP, asbestos cement, HDPE, MDPE, PVC, uPVC, ABS

1.4462 Duplex casings and fasteners available on request.

Repair Coupling Dimensions

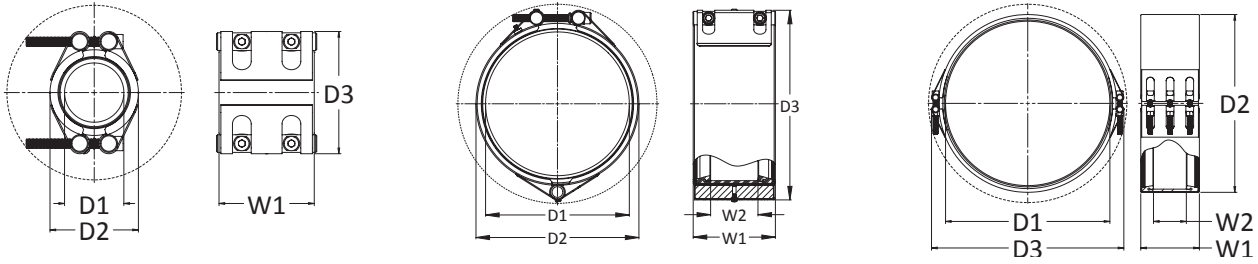

D1 Pipe O.D.	Pipe Nominal Bore	Available Coupling Widths:						Working Pressure Available in the following PN ratings:	W2	D2 Coupling O.D. = D1 (mm) + the following:
		(mm)	85 mm	110 mm	140 mm	210 mm	310 mm			
Teekay Repair Couplings are available to suit any pipe O.D. up to 3000 mm. Please contact us with OD prior to order placement.	40	●						16 / 25 / 40	42	20
	50	●						16 / 25 / 40	42	20
	75		●					16 / 25 / 40	67	22
	100		●					16 / 25 / 40	67	22
	150		●	●				16 / 25 / 40	67 / 80	22 / 28
	200		●	●	●			16 / 25 / 40	67 / 80 / 120	22 / 28 / 42
	250		●	●	●			16 / 25 / 40	67 / 80 / 120	22 / 28 / 42
	300		●	●	●	●	●	10 / 16 / 25	67 / 80 / 120 / 220 / 320	22 / 28 / 42 / 42 / 42
	350			●	●	●	●	10 / 16 / 25	80 / 120 / 220 / 320	28 / 42 / 42 / 42
	400			●	●	●	●	10 / 16 / 25	80 / 120 / 220 / 320	28 / 42 / 42 / 42
	450			●	●	●	●	10 / 16 / 25	80 / 120 / 220 / 320	28 / 42 / 42 / 42
	500			●	●	●	●	6 / 10 / 16	80 / 120 / 220 / 320	28 / 42 / 42 / 42
	600			●	●	●	●	6 / 10 / 16	80 / 120 / 220 / 320	28 / 42 / 42 / 42
	700			●	●	●	●	6 / 10 / 16	80 / 120 / 220 / 320	28 / 42 / 42 / 42
	800			●	●	●	●	6 / 10 / 16	80 / 120 / 220 / 320	28 / 42 / 42 / 42
	900			●	●	●	●	2.5 / 6 / 10	80 / 120 / 220 / 320	28 / 42 / 42 / 42
	1000			●	●	●	●	2.5 / 6 / 10	80 / 120 / 220 / 320	28 / 42 / 42 / 42
	1100			●	●	●	●	2.5 / 6 / 10	80 / 120 / 220 / 320	28 / 42 / 42 / 42
	1200			●	●	●	●	2.5 / 6 / 10	80 / 120 / 220 / 320	28 / 42 / 42 / 42
	1300			●	●	●	●	2.5 / 6	80 / 120 / 220 / 320	28 / 42 / 42 / 42
	1400			●	●	●	●	2.5 / 6	80 / 120 / 220 / 320	28 / 42 / 42 / 42
	1500			●	●	●	●	2.5 / 6	80 / 120 / 220 / 320	28 / 42 / 42 / 42
	1600				●	●	●	2.5 / 6	120 / 220 / 320	42 / 42 / 42
	1700				●	●	●	2.5 / 6	120 / 220 / 320	42 / 42 / 42
	1800				●	●	●	2.5 / 6	120 / 220 / 320	42 / 42 / 42
	1900				●	●	●	2.5 / 6	120 / 220 / 320	42 / 42 / 42
	2000				●	●	●	2.5 / 6	120 / 220 / 320	42 / 42 / 42
	2100				●	●	●	2.5	120 / 220 / 320	42 / 42 / 102
	2200				●	●	●	2.5	120 / 220 / 320	42 / 42 / 102
	2300				●	●	●	2.5	120 / 220 / 320	42 / 42 / 102
2400				●	●	●	2.5	120 / 220 / 320	42 / 42 / 102	
2500				●	●	●	2.5	120 / 220 / 320	42 / 42 / 102	
2600				●	●	●	2.5	120 / 220 / 320	42 / 42 / 102	
2700				●	●	●	2.5	120 / 220 / 320	42 / 42 / 102	
2800				●	●	●	2.5	120 / 220 / 320	42 / 42 / 102	
2900				●	●	●	2.5	120 / 220 / 320	42 / 42 / 102	
3000				●	●	●	2.5	120 / 220 / 320	42 / 42 / 102	

As illustrated above, Teekay Repair Couplings can be supplied in hinged or double lockpart versions to suit applications where tolerance or accessibility may be critical.

D3 Overall Coupling O.D. = D1 (mm) + the following:	Number of Screws	Approximate Weight	Maximum Allowable Tolerance on Pipe O.D. +/-	Pipe Nominal Bore	D1 Pipe O.D.
(mm)		(KG)	(mm)	(mm)	
58	4	2.2	2	40	Teekay Repair Couplings are available to suit any pipe O.D. up to 3000 mm. Please contact us with OD prior to order placement.
58	4	2.6	2	50	
66	2	3	2	75	
66	2	3	2	100	
66 / 88	2 / 2	4 / 5	2.5 / 2.5	150	
66 / 88 / 102	2 / 2 / 2	4 / 6 / 10	3 / 3 / 3	200	
66 / 88 / 102	2 / 2 / 2	5 / 6 / 10	3 / 3 / 3	250	
66 / 88 / 102 / 102 / 102	2 / 2 / 2 / 4 / 6	5 / 7 / 11 / 21 / 27	3 / 4 / 4 / 4 / 4	300	
88 / 102 / 102 / 102	2 / 3 / 4 / 6	8 / 13 / 22 / 29	4 / 4 / 4 / 4	350	
88 / 102 / 102 / 102	2 / 3 / 4 / 6	9 / 15 / 24 / 31	4 / 4 / 4 / 4	400	
88 / 102 / 102 / 102	2 / 3 / 4 / 6	11 / 16 / 26 / 34	4 / 4 / 4 / 4	450	
88 / 102 / 102 / 102	2 / 3 / 4 / 6	11 / 18 / 31 / 38	4 / 4 / 4 / 4	500	
88 / 102 / 102 / 102	2 / 3 / 4 / 6	13 / 20 / 35 / 45	4 / 5 / 5 / 5	600	
88 / 102 / 102 / 102	2 / 3 / 4 / 6	14 / 25 / 39 / 50	4 / 5 / 5 / 5	700	
88 / 102 / 102 / 102	2 / 3 / 4 / 6	16 / 27 / 43 / 55	4 / 5 / 5 / 5	800	
88 / 102 / 102 / 102	2 / 3 / 4 / 6	18 / 30 / 46 / 61	4 / 5 / 5 / 5	900	
88 / 102 / 102 / 102	2 / 3 / 4 / 6	19 / 33 / 50 / 66	4 / 5 / 5 / 5	1000	
88 / 102 / 102 / 102	2 / 3 / 4 / 6	20 / 41 / 54 / 71	4 / 5 / 5 / 5	1100	
88 / 102 / 102 / 102	2 / 3 / 4 / 6	22 / 44 / 58 / 76	4 / 5 / 5 / 5	1200	
88 / 102 / 102 / 102	4 / 6 / 8 / 12	27 / 48 / 64 / 83	4 / 6 / 6 / 6	1300	
88 / 102 / 102 / 102	4 / 6 / 8 / 12	29 / 51 / 68 / 90	4 / 6 / 6 / 6	1400	
88 / 102 / 102 / 102	4 / 6 / 8 / 12	32 / 53 / 72 / 95	4 / 6 / 6 / 6	1500	
102 / 102 / 102	4 / 6 / 8 / 12	57 / 76 / 100	6 / 6 / 6	1600	
102 / 102 / 102	4 / 6 / 8 / 12	60 / 80 / 105	6 / 6 / 6	1700	
102 / 102 / 102	4 / 6 / 8 / 12	62 / 84 / 110	6 / 6 / 6	1800	
102 / 102 / 102	4 / 6 / 8 / 12	62 / 84 / 115	6 / 6 / 6	1900	
102 / 102 / 102	4 / 6 / 8 / 12	65 / 88 / 120	6 / 6 / 6	2000	
102 / 102 / 102	4 / 6 / 8 / 24	68 / 91 / 142	6 / 6 / 6	2100	
102 / 102 / 102	12 / 16 / 24	72 / 95 / 148	6 / 6 / 6	2200	
102 / 102 / 102	12 / 16 / 24	75 / 99 / 152	6 / 6 / 6	2300	
102 / 102 / 102	12 / 16 / 24	78 / 103 / 157	6 / 6 / 6	2400	
102 / 102 / 102	12 / 16 / 24	89 / 118 / 160	12 / 12 / 12	2500	
102 / 102 / 102	12 / 16 / 24	92 / 122 / 168	12 / 12 / 12	2600	
102 / 102 / 102	12 / 16 / 24	95 / 126 / 173	12 / 12 / 12	2700	
102 / 102 / 102	12 / 16 / 24	98 / 130 / 178	12 / 12 / 12	2800	
102 / 102 / 102	12 / 16 / 24	101 / 134 / 183	12 / 12 / 12	2900	
102 / 102 / 102	12 / 16 / 24	104 / 138 / 189	12 / 12 / 12	3000	

NOTES: The above tables are guides to the most common sizes. Couplings to suit specific outside diameters not listed may be manufactured to order. Please contact us for further details. Minimum burst is 1.5 times working pressure. Figures are based on typical values for standard wall carbon steel pipe. For use on thin or soft pipe materials such as thin wall stainless, copper alloy or plastic (by way of example only) please check with us first.

Stepped Coupling



The Teekay Stepped coupling is a “problem-solver” on any site with the ability to join pipes of different ODs and different materials.

Typical applications:

- refurbishments (where the contractor is connecting a piping system back into the original layout)
- repairs to old water mains (where the pipe is so corroded it needs to be replaced with a new material in metric size)
- chamber connections
- pipe material transitions
- joining metallic pipe to plastic pipe

Material Selection

Type I

Casing: AISI 304/ DIN 1.4301
Fasteners: Alloy Steel, Coated
Gasket: EPDM/NBR/H-NBR/FKM/VMQ

Type II

Casing: AISI 304/ DIN 1.4301
Fasteners: AISI 316/ 316L
Gasket: EPDM/NBR/H-NBR/FKM/VMQ

Type IV

Casing: AISI 316L/ DIN 1.4404
Fasteners: AISI 316/ 316L
Gasket: EPDM/NBR/H-NBR/FKM/VMQ

Type V

Casing: High strength steel
Coating: Rilsan/PVC/
Epoxy/Galvanized
Fasteners: Alloy Steel, Coated
Gasket: EPDM/NBR/H-NBR/FKM/VMQ

Type VI

Casing: High strength steel
Coating: Rilsan/PVC/
Epoxy/Galvanized
Fasteners: AISI 316/ 316L
Gasket: EPDM/NBR/H-NBR/FKM/VMQ

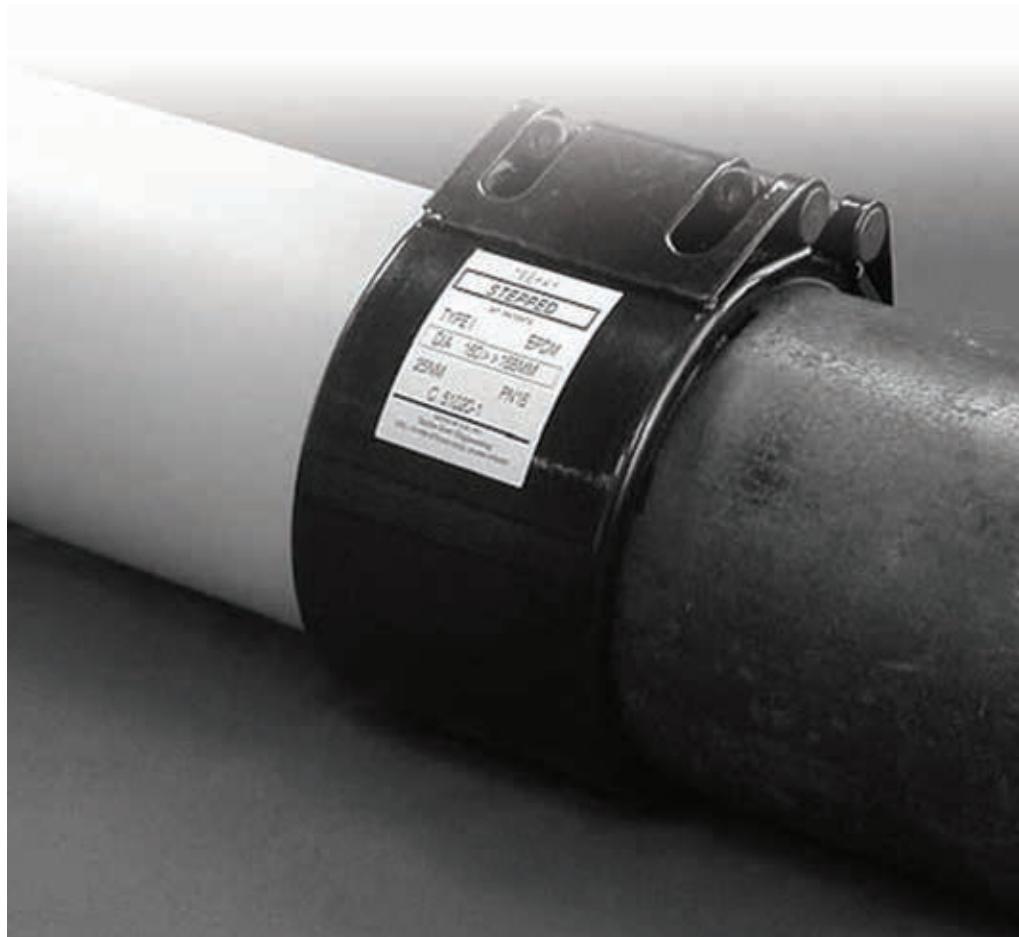

Sizes: 48.3 mm to 3000.0 mm

Gaskets: EPDM -40°C to +100°C, NBR -20°C to +80°C, HNBR -20°C to +130°C, Viton -20°C to +250°C, Silicone -70°C to +270°C (*depending on grade*)

Pipe Materials: Carbon steel, cast and ductile iron, stainless steel, copper, cupifer, GRP, asbestos cement, HDPE, MDPE, PVC, uPVC, ABS

1.4462 Duplex casings and fasteners available on request.

Stepped Coupling Dimensions

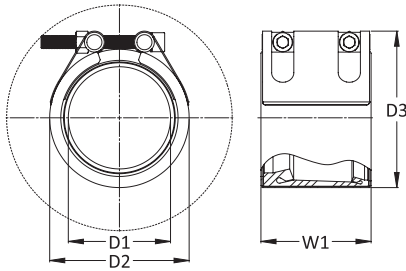

Pipe O.D. (smaller pipe)	Available Coupling Widths				Maximum Step (mm)	Maximum Pressure Rating PN	No. Of Screws	Screw Size	Approximate Weight KG
	85 mm	110 mm	140 mm	210 mm					
48.3 - 56	●				+ 5	16	2	M8	1
57 - 72	●				+ 5	16	2	M8	1
73 - 82.5	●				+ 5	16	2	M8	1
83 - 99		●			+ 12	16	2	M10	2
100 - 102		●			+ 15	16	2	M10	2
100 - 127		●			+ 15	16	2	M10	2
128 - 150		●			+ 15	16	2	M10	2.5
151 - 186		●	●		+ 15 / + 20	16 / 16	2 / 2	M10 / 16	2.5 / 4
187 - 205		●	●		+ 15 / + 20	16 / 16	2 / 2	M10 / 16	2.5 / 4
200 - 240		●	●		+ 15 / + 25	16 / 16	2 / 2	M10 / 16	3 / 4.5
241 - 260		●	●	●	+ 15 / + 25 / + 25	16 / 16 / 16	2 / 2 / 3	M10 / 16 / 16	3.5 / 5 / 8
250 - 286		●	●	●	+ 15 / + 25 / + 25	16 / 16 / 16	2 / 2 / 3	M10 / 16 / 16	3.5 / 5 / 8.5
287 - 326		●			+ 15	10	2	M10	4
287 - 349			●	●	+ 25 / + 25	16 / 16	2 / 3	M16 / 16	6 / 10
350 - 399			●	●	+ 25 / + 25	16 / 16	2 / 3	M16 / 16	7 / 11
400 - 453			●	●	+ 25 / + 25	16 / 16	2 / 3	M16 / 16	8 / 13
450 - 507			●	●	+ 25 / + 25	10 / 16 / 10 / 16	2 / 3	M16 / 16	9 / 14
500 - 560			●	●	+ 25 / + 25	10 / 16 / 10 / 16	2 / 3	M16 / 16	9.5 / 16
561 - 667			●	●	+ 25 / + 25	10 / 16 / 10 / 16	2 / 3	M16 / 16	11 / 17.5
668 - 750			●	●	+ 25 / + 25	10 / 10 / 16	2 / 3	M16 / 16	12.5 / 22.5
751 - 850			●	●	+ 25 / + 25	10 / 10 / 16	2 / 3	M16 / 16	14 / 25
851 - 950			●	●	+ 25 / + 25	10 / 10 / 16	2 / 3	M16 / 16	16 / 28
951 - 1050			●	●	+ 25 / + 25	6 / 6	2 / 3	M16 / 16	17 / 30
1051 - 1150			●	●	+ 25 / + 25	6 / 6	2 / 3	M16 / 16	18 / 38
1151 - 1250			●	●	+ 25 / + 25	2.5 / 6 / 2.5 / 6	2 / 3	M16 / 16	20 / 41
1251 - 1350				●	+ 25	2.5 / 6	6	M16	48
1351 - 1450				●	+ 25	2.5 / 6	6	M16	50.5
1451 - 1550				●	+ 25	2.5 / 6	6	M16	53
1551 - 1650				●	+ 25	2.5 / 6	6	M16	56.5
1651 - 1750				●	+ 25	2.5 / 5	6	M16	60
1751 - 1850				●	+ 25	2.5 / 5	6	M16	62.5
1851 - 1950				●	+ 25	2.5 / 5	6	M16	65
1951 - 2050				●	+ 25	2.5 / 5	6	M16	68
2051 - 2150				●	+ 25	2.5 / 4	6	M16	71
2151 - 2250				●	+ 25	2.5 / 4	12	M16	74
2251 - 2350				●	+ 25	2.5 / 4	12	M16	76
2351 - 2450				●	+ 25	2.5 / 4	12	M16	80
2451 - 2550				●	+ 25	2.5 / 3	12	M16	87.5
2551 - 2650				●	+ 25	2.5 / 3	12	M16	93
2651 - 2750				●	+ 25	2.5 / 3	12	M16	96
2751 - 2850				●	+ 25	2.5 / 3	12	M16	99
2851 - 2950				●	+ 25	2 / 3	12	M16	110
2951 - 3050				●	+ 25	2 / 3	12	M16	121

NOTES: See Notes page 18.

The Teekay Stepped Coupling is a non-axial restraint pipe coupling type.

Reducer and Flanged Reducer



Coupling Material Selection

Type I

Casing: AISI 304/ DIN 1.4301
Fasteners: Alloy Steel, Coated
Gasket: EPDM/NBR/H-NBR/FKM/VMQ

Type II

Casing: AISI 304/ DIN 1.4301
Fasteners: AISI 316/ 316L
Gasket: EPDM/NBR/H-NBR/FKM/VMQ

Type IV

Casing: AISI 316L/ DIN 1.4404
Fasteners: AISI 316/ 316L
Gasket: EPDM/NBR/H-NBR/FKM/VMQ

Type V

Casing: High strength steel
Coating: Rilsan/PVC/
Epoxy/Galvanized
Fasteners: Alloy Steel, Coated
Gasket: EPDM/NBR/H-NBR/FKM/VMQ

Type VI

Casing: High strength steel
Coating: Rilsan/PVC/
Epoxy/Galvanized
Fasteners: AISI 316/ 316L
Gasket: EPDM/NBR/H-NBR/FKM/VMQ

Have you got two pipes to join with a large difference in outside diameters? Use a Teekay reducer to make the connection!

Teekay reducers can be fabricated to suit any pipe O.D. and are available in both concentric and eccentric configurations. Two pipe couplings are supplied, one on either end of the reducer, with a choice of Axiflex or Axilock (depending on diameter and pressure).

Teekay also manufactures Flanged Reducers for connecting flanged pieces of equipment to plain end sections of pipe of a different size.

Please contact Teekay for further details.



Sizes: Smallest OD = 38.0 mm, Largest OD = 2000 mm.

Reducer Materials: Stainless Steel Options = AISI 304 / AISI 316L.
Coated Steel Options = Galvanized / Rilsan / PVC / Epoxy

Gaskets: EPDM -40°C to +100°C, NBR -20°C to +80°C,
HNBR -20°C to +130°C, Viton -20°C to +250°C,
Silicone -70°C to +270°C (*depending on grade*)

Pipe Materials: Carbon steel, cast and ductile iron, stainless steel,
copper, cupifer, GRP, concrete, asbestos cement,
HDPE



Teekay Flange Adaptors make the installation of pumps and valves quicker and easier. Simply bolt the flange adaptor on to the existing flange and fasten the coupling over the joint between the flange adaptor and plain end pipe. This creates a useful maintenance point in the future: undo the bolts on the coupling rather than the nuts on the flange adaptor and lift out the piece of equipment!

Teekay Flange Adaptors can be fabricated to any pipe O.D. and are available in standard and non-standard drillings. Choose an Axiflex coupling to accommodate expansion and contraction or an Axilock for a fully anchored solution (depending on diameter and pressure).

Coupling Material Selection

Type I

Casing: AISI 304/ DIN 1.4301
Fasteners: Alloy Steel, Coated
Gasket: EPDM/NBR/H-NBR/FKM/VMQ

Type II

Casing: AISI 304/ DIN 1.4301
Fasteners: AISI 316/ 316L
Gasket: EPDM/NBR/H-NBR/FKM/VMQ

Type IV

Casing: AISI 316L/ DIN 1.4404
Fasteners: AISI 316/ 316L
Gasket: EPDM/NBR/H-NBR/FKM/VMQ

Type V

Casing: High strength steel
Coating: Rilsan/PVC/
 Epoxy/Galvanized
Fasteners: Alloy Steel, Coated
Gasket: EPDM/NBR/H-NBR/FKM/VMQ

Type VI

Casing: High strength steel
Coating: Rilsan/PVC/
 Epoxy/Galvanized
Fasteners: AISI 316/ 316L
Gasket: EPDM/NBR/H-NBR/FKM/VMQ



Sizes: Smallest OD = 48.3 mm, Largest OD = 2000 mm.

Flange Adaptor materials: Stainless Steel Options = AISI 304 / AISI 316L.
 Coated Steel = Galvanized / Rilsan / PVC / Epoxy

Gaskets: EPDM -40°C to +100°C, NBR -20°C to +80°C,
 HNBR -20°C to +130°C, Viton -20°C to +250°C,
 Silicone -70°C to +270°C (*depending on grade*)

Pipe Materials: Carbon steel, cast and ductile iron, stainless steel, copper, cunifer, GRP

1.4462 Duplex casings and fasteners available on request.

Flange Adaptor Dimensions

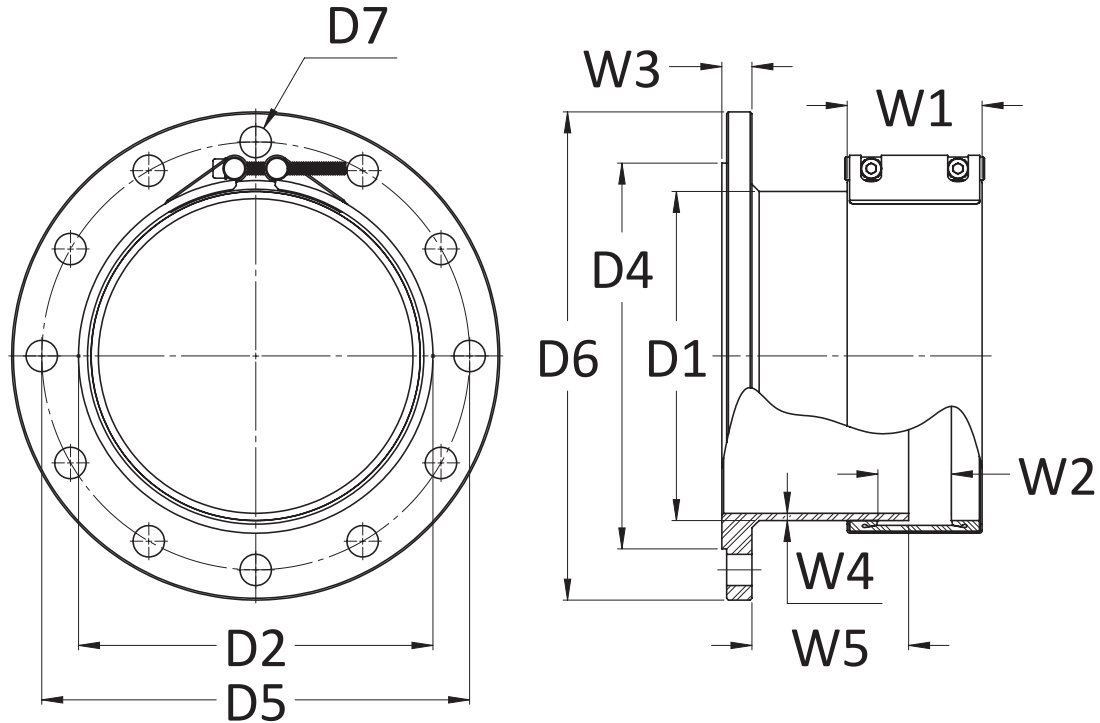

Flange Adaptor PN25 (25 bar)

To suit flanges drilled BS 4504

Pipe Details		Coupling Details				Spigot Details		Flange Details						Approx. Weight	
Nom. Pipe Size	D1 Pipe O.D.	D2 Coupling O.D. = (D1+D2)	W1 Coupling Width	W2 Gap Between Sealing Lips	No. of Screws	W5 Length of Spigot	W4 Spigot Thickness	D4 Raised Face Diameter	D5 Pitch Circle Diameter	D6 Flange O.D.	D7 Bolt Hole Diameter	W3 Flange Thickness	No. of Bolts	Bolt Diameter	KGS
50	Teekay Flange Adaptors can be manufactured to suit any pipe outside diameter.	22	110	67	2	120	6	102	125	165	18	20	4	M16	5.0
65		22	110	67	2	120	6	122	145	185	18	20	8	M16	7.5
80		22	110	67	2	120	6	138	160	200	18	20	8	M16	9.0
100		22	110	67	2	120	6	162	190	235	22	20	8	M20	10.5
125		22	110	67	2	120	6	188	220	270	26	20	8	M24	12.0
150		28	140	80	2	150	6	218	250	300	26	20	8	M24	13.5
175		28	140	80	2	150	6	248	280	330	26	20	12	M24	14.2
200		28	140	80	2	150	6	278	310	360	26	20	12	M24	18.5
250		28	140	80	2	153	6	335	370	425	30	20	12	M27	24.9
300		28	140	80	2	147	6	395	430	485	30	25	16	M27	34.0
350		28	140	80	2	143	6	450	490	555	33	25	16	M30	53.0
400		28	140	80	2	159	6	505	550	620	36	25	16	M33	65.0
450		28	140	80	2	153	6	555	600	670	36	25	20	M33	84.5
500		28	140	80	2	147	6	615	660	730	36	25	20	M33	102.8
600		28	140	80	2	139	6	720	770	845	39	25	20	M36	146.3

Flange Adaptor PN16 (16 bar)

To suit flanges drilled BS 4504 PN16 DIN 2532 PN16 BS4772

Pipe Details		Coupling Details				Spigot Details		Flange Details						Approx. Weight	
Nom. Pipe Size	D1 Pipe O.D.	D2 Coupling O.D. = (D1+D2)	W1 Coupling Width	W2 Gap Between Sealing Lips	No. of Screws	W5 Length of Spigot	W4 Spigot Thickness	D4 Raised Face Diameter	D5 Pitch Circle Diameter	D6 Flange O.D.	D7 Bolt Hole Diameter	W3 Flange Thickness	No. of Bolts	Bolt Diameter	KGS
50	Teekay Flange Adaptors can be manufactured to suit any pipe outside diameter.	20	85	42	2	95	3	102	125	165	18	10	4	M16	5.0
65		20	85	42	2	95	3	122	145	185	18	10	4	M16	6.0
80		20	85	42	2	95	6	138	160	200	18	10	8	M16	6.3
100		20	85	42	2	95	6	158	180	220	18	10	8	M16	7.8
125		20	85	42	2	95	6	188	210	250	18	10	8	M16	10.2
150		22	110	67	2	120	6	212	240	285	22	10	8	M20	13.5
175		22	110	67	2	120	6	242	270	315	22	20	8	M20	15.8
200		22	110	67	2	120	6	268	295	340	22	20	12	M20	17.5
250		22	110	67	2	130	6	320	355	405	26	20	12	M24	21.2
300		28	140	80	2	160	6	FF	410	460	26	25	12	M24	30.0
350		28	140	80	2	160	6	FF	470	520	26	25	16	M24	36.5
400		28	140	80	2	160	6	FF	525	580	30	25	16	M27	42.7
450		28	140	80	2	160	6	FF	585	640	30	25	20	M27	50.5
500		28	140	80	2	160	6	FF	650	715	33	25	20	M30	62.2
600		28	140	80	2	160	6	FF	770	840	36	25	20	M33	78.0
700		42	210	120	3	230	6	FF	840	910	36	25	24	M33	90.5
800		42	210	120	3	230	8	FF	950	1025	39	25	24	M36	118.4
900		42	210	120	3	230	8	FF	1050	1125	39	25	28	M36	131.0
1000		42	210	120	3	230	10	FF	1170	1255	42	25	28	M39	154.7
1200		42	210	120	3	217	10	FF	1390	1485	48	38	32	M45	251.0

Flange Adaptor PN10 (10 bar)

To suit flanges drilled BS 4504 PN10 DIN 2532 PN10 BS4772 PN10

Pipe Details		Coupling Details				Spigot Details		Flange Details						Approx. Weight	
Nom. Pipe Size	D1 Pipe O.D.	D2 Coupling O.D. = (D1+D2)	W1 Coupling Width	W2 Gap Between Sealing Lips	No. of Screws	W5 Length of Spigot	W4 Spigot Thickness	D4 Raised Face Diameter	D5 Pitch Circle Diameter	D6 Flange O.D.	D7 Bolt Hole Diameter	W3 Flange Thickness	No. of Bolts	Bolt Diameter	KGS
50	Teekay Flange Adaptors can be manufactured to suit any pipe outside diameter.	20	85	42	2	95	3	102	125	165	18	10	4	M16	4.2
65		20	85	42	2	95	3	122	145	185	18	10	4	M16	4.7
80		20	85	42	2	95	6	138	160	200	18	10	8	M16	6.8
100		20	85	42	2	95	6	158	180	220	18	10	8	M16	7.9
125		20	85	42	2	95	6	188	210	250	18	10	8	M16	9.7
150		22	110	67	2	120	6	212	240	285	22	10	8	M20	12.4
175		22	110	67	2	120	6	242	270	315	22	20	8	M20	14.4
200		22	110	67	2	120	6	268	295	340	22	20	8	M20	15.9
250		22	110	67	2	130	6	320	350	395	22	20	12	M20	18.9
300		22	110	67	2	130	6	370	400	445	22	25	12	M20	21.8
350		28	140	80	2	160	6	FF	460	505	22	25	16	M20	34.0
400		28	140	80	2	160	6	FF	515	565	26	25	16	M24	40.0
450		28	140	80	2	160	6	FF	565	615	26	25	20	M24	45.3
500		28	140	80	2	160	6	FF	620	670	26	25	20	M24	50.1
600		28	140	80	2	160	6	FF	725	780	30	25	20	M27	62.7
700		42	210	120	3	230	6	FF	840	895	30	25	24	M27	86.2
800		42	210	120	3	230	8	FF	950	1015	33	25	24	M30	115.2
900		42	210	120	3	230	8	FF	1050	1115	33	25	28	M30	127.5
1000		42	210	120	3	230	10	FF	1160	1230	36	25	28	M33	144.9
1200		42	210	120	3	217	10	FF	1380	1455	39	38	32	M36	229.8
1400	42	210	120	6	217	10	FF	1570	1675	43	38	36	M39	316.5	
1600	42	210	120	6	245	10	FF	1820	1915	49	60	40	M45	529.3	

Flange Adaptor Dimensions

Flange Adaptor PN6 (6 bar)

To suit flanges drilled BS 4504

Pipe Details		Coupling Details				Spigot Details		Flange Details							Approx. Weight
Nom. Pipe Size	D1 Pipe O.D.	D2 Coupling O.D. = (D1+D2)	W1 Coupling Width	W2 Gap Between Sealing Lips	No. of Screws	W5 Length of Spigot	W4 Spigot Thickness	D4 Raised Face Diameter	D5 Pitch Circle Diameter	D6 Flange O.D.	D7 Bolt Hole Diameter	W3 Flange Thickness	No. of Bolts	Bolt Diameter	KGS
50	Teekay Flange Adaptors can be manufactured to suit any pipe outside diameter.	20	85	42	2	95	3	90	110	140	14	10	4	M12	3.5
65		20	85	42	2	95	3	110	130	160	14	10	4	M12	4.0
80		20	85	42	2	95	6	128	150	190	18	10	4	M16	5.1
100		20	85	42	2	95	6	148	170	210	18	10	4	M16	6.4
125		20	85	42	2	95	6	178	200	240	18	10	8	M16	8.1
150		22	110	67	2	120	6	202	225	265	18	10	8	M16	9.5
200		22	110	67	2	120	6	258	280	320	18	20	8	M16	12.9
250		22	110	67	2	120	6	312	335	375	18	20	12	M16	15.9
300		22	110	67	2	120	6	365	395	440	22	25	12	M20	19.5
350		28	140	80	2	160	6	415	445	490	22	25	12	M20	31.7
400		28	140	80	2	160	6	FF	495	540	22	25	16	M20	36.6
450		28	140	80	2	160	6	FF	550	595	22	25	16	M20	41.5
500		28	140	80	2	160	6	FF	600	645	22	25	20	M20	45.0
600		28	140	80	2	160	6	FF	705	755	26	25	20	M24	56.7
700		42	210	120	3	230	6	FF	810	860	26	25	24	M24	76.6
800		42	210	120	3	230	8	FF	920	975	30	25	24	M27	102.7
900		42	210	120	3	230	8	FF	1020	1075	30	25	24	M27	113.7
1000		42	210	120	3	230	10	FF	1120	1175	30	25	28	M27	124.0
1200		42	210	120	3	230	10	FF	1340	1405	33	38	32	M30	195.6
1400		42	210	120	6	230	10	FF	1560	1630	36	38	36	M33	280.9
1600	42	210	120	6	245	10	FF	1760	1830	36	60	40	M33	409.0	
1800	42	210	120	6	245	15	FF	1970	2045	39	60	44	M36	511.1	
2000	42	210	120	6	245	15	FF	2180	2265	42	60	48	M39	597.8	

Flange Adaptor PN2.5 (2.5 bar)

To suit flanges drilled BS 4504

Pipe Details		Coupling Details				Spigot Details		Flange Details							Approx. Weight
Nom. Pipe Size	D1 Pipe O.D.	D2 Coupling O.D. = (D1+D2)	W1 Coupling Width	W2 Gap Between Sealing Lips	No. of Screws	W5 Length of Spigot	W4 Spigot Thickness	D4 Raised Face Diameter	D5 Pitch Circle Diameter	D6 Flange O.D.	D7 Bolt Hole Diameter	W3 Flange Thickness	No. of Bolts	Bolt Diameter	KGS
1200	Teekay Flange Adaptors can be manufactured to suit any pipe outside diameter.	42	210	120	3	219	10	1280	1320	1375	30	38	32	M27	164.2
1400		42	210	120	6	213	10	1480	1520	1575	30	38	36	M27	225.4
1600		42	210	120	6	259	10	1690	1730	1790	30	60	40	M27	281.4
1800		42	210	120	6	253	15	1890	1930	1990	30	60	44	M27	356.5
2000		42	210	120	6	247	15	2090	2130	2190	30	60	48	M27	446.2

Other flange tables and drillings such as BS10 Tables A-E or BS1506/ANSI B16.5 Classes 150 and 300 can be supplied as standard. Different or non-standard drillings are also readily available. Dimensions for these are available from the Teekay Technical Department.

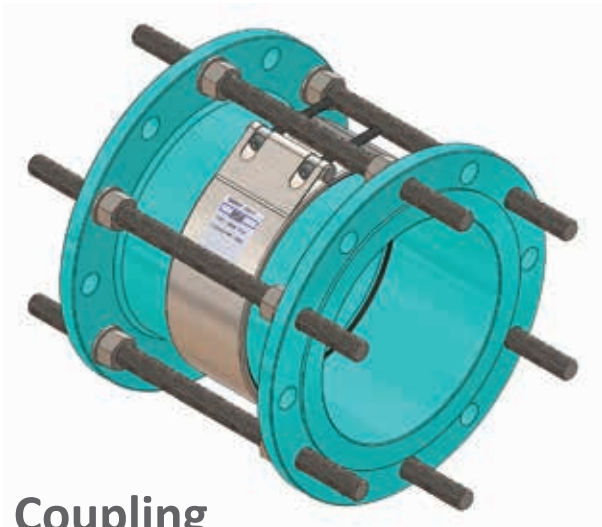

Teekay Dismantling Joints facilitate the easy access and removal of equipment when it comes to long-term maintenance of piping systems. Rather than moving large sections of fixed pipework, use the Dismantling Joint to create space and easy access to pumps, valves and flowmeters.

Teekay Dismantling Joints enable up to 100 mm of longitudinal adjustment. Each joint comes with a Teekay Axiflex coupling and axial restraint is provided by the high tensile steel tie bars.

Coupling Material Selection

Type I

Casing: AISI 304/ DIN 1.4301
Fasteners: Alloy Steel, Coated
Gasket: EPDM/NBR/H-NBR/FKM/VMQ

Type II

Casing: AISI 304/ DIN 1.4301
Fasteners: AISI 316/ 316L
Gasket: EPDM/NBR/H-NBR/FKM/VMQ

Type IV

Casing: AISI 316L/ DIN 1.4404
Fasteners: AISI 316/ 316L
Gasket: EPDM/NBR/H-NBR/FKM/VMQ

Type V

Casing: High strength steel
Coating: Rilsan/PVC/
 Epoxy/Galvanized
Fasteners: Alloy Steel, Coated
Gasket: EPDM/NBR/H-NBR/FKM/VMQ

Type VI

Casing: High strength steel
Coating: Rilsan/PVC/
 Epoxy/Galvanized
Fasteners: AISI 316/ 316L
Gasket: EPDM/NBR/H-NBR/FKM/VMQ



Sizes: Smallest OD = 48.3 mm, Largest OD = 2000 mm.

Dismantling Joint materials: Stainless Steel Options = AISI 304 / AISI 316L.
 Coated Steel Options = Galvanized / Rilsan / PVC / Epoxy

Gaskets: EPDM -40°C to +100°C, NBR -20°C to +80°C, HNBR -20°C to +130°C, Viton -20°C to +250°C, Silicone -70°C to +270°C (*depending on grade*)

Pipe Materials: Carbon steel, cast and ductile iron, stainless steel, copper, cupifer, GRP

1.4462 Duplex casings and fasteners available on request.

Dismantling Joint Dimensions

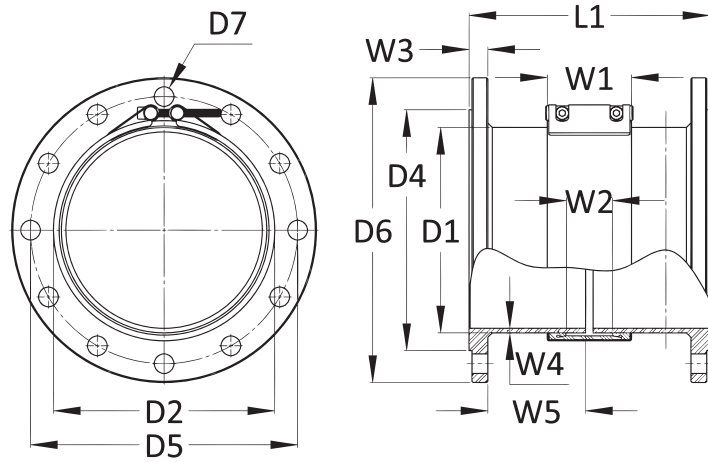

Dismantling Joint PN16 (16 bar)

To suit flanges drilled BS 4504 PN16 DIN 2532 PN16 BS4772

Size	Overall Length		Coupling Details			Tie Bar Details			Flange Details			Approx. Weight		
Nom. Pipe Size	L1 (minimum)	L1 (maximum)	W1 Coupling Width	No. of Screws	Screw Size	No. of Tie Bars	Diameter	Length	D5 Pitch Circle Diameter	D6 Flange O.D.	D7 Bolt Hole Diameter	W3 Flange Thickness	No. of Bolts	KGS
40	125	165	85	2	M8	4	M16	300	110	150	18	10	4	9.0
50	125	165	85	2	M8	4	M16	300	125	165	18	10	4	10.0
65	125	165	85	2	M8	4	M16	300	145	185	18	10	4	12.0
80	150	190	110	2	M10	4	M16	300	160	200	18	10	8	12.6
100	150	190	110	2	M10	4	M16	300	180	220	18	10	8	15.6
125	150	190	110	2	M10	4	M16	300	210	250	18	10	8	20.4
150	150	190	110	2	M10	4	M20	310	240	285	22	10	8	27.0
175	170	210	110	2	M10	4	M20	310	270	315	22	20	8	31.6
200	170	210	110	2	M10	4	M20	310	295	340	22	20	12	35.0
250	170	210	110	2	M10	4	M24	330	355	405	26	20	12	42.4
300	210	270	140	2	M16	4	M24	330	410	460	26	25	12	60.0
350	210	270	140	2	M16	4	M24	460	470	520	26	25	16	73.0
400	210	270	140	2	M16	4	M27	490	525	580	30	25	16	85.4
450	210	270	140	2	M16	5	M27	490	585	640	30	25	20	101.0
500	210	270	140	2	M16	5	M30	500	650	715	33	25	20	124.4
600	210	270	140	2	M16	5	M33	515	770	840	36	25	20	156.0
700	270	350	210	3	M16	6	M33	565	840	910	36	25	24	181.0
800	270	350	210	3	M16	6	M36	570	950	1025	39	25	24	236.8
900	270	350	210	3	M16	7	M36	595	1050	1125	39	25	28	262.0
1000	270	350	210	3	M16	7	M39	615	1170	1255	42	25	28	309.4
1200	320	400	210	3	M16	8	M45	630	1390	1485	48	38	32	502.0
1400	320	400	210	6	M16	9	M45	665	1590	1685	48	38	36	618.0
1600	320	420	210	6	M16	10	M52	870	1820	1930	56	38	40	830.0
1800	320	420	210	6	M16	11	M52	900	2020	2130	56	38	44	991.0
2000	390	490	210	6	M16	12	M56	960	2230	2345	62	60	48	1488.0

Dismantling Joint PN10 (10 bar)

To suit flanges drilled BS 4504 PN10 DIN 2532 PN10 BS4772 PN10

Size	Overall Length		Coupling Details			Tie Bar Details			Flange Details			Approx. Weight		
Nom. Pipe Size	L1 (minimum)	L1 (maximum)	W1 Coupling Width	No. of Screws	Screw Size	No. of Tie Bars	Diameter	Length	D5 Pitch Circle Diameter	D6 Flange O.D.	D7 Bolt Hole Diameter	W3 Flange Thickness	No. of Bolts	KGS
200	170	210	110	2	M10	4	M20	310	295	340	22	20	8	31.0
250	170	210	110	2	M10	4	M20	330	350	395	22	20	12	34.0
300	210	270	140	2	M16	4	M20	330	400	445	22	25	12	49.0
350	210	270	140	2	M16	4	M20	460	460	505	22	25	16	63.0
400	210	270	140	2	M16	4	M24	490	515	565	26	25	16	77.0
450	210	270	140	2	M16	5	M24	490	565	615	26	25	20	90.0
500	210	270	140	2	M16	5	M24	500	620	670	26	25	20	100.0
600	210	270	140	2	M16	5	M27	515	725	780	30	25	20	117.0
700	270	350	210	3	M16	6	M27	565	840	895	30	25	24	164.0
800	270	350	210	3	M16	6	M30	570	950	1015	33	25	24	213.0
900	270	350	210	3	M16	7	M30	595	1050	1115	33	25	28	233.0
1000	270	350	210	3	M16	7	M33	615	1160	1230	36	25	28	290.0
1200	320	400	210	3	M16	8	M36	630	1380	1455	39	38	32	478.0
1400	320	400	210	6	M16	9	M39	665	1590	1675	42	38	36	593.0
1600	320	420	210	6	M16	10	M45	870	1820	1915	48	38	40	772.0
1800	320	420	210	6	M16	11	M45	900	2020	2115	48	38	44	859.0
2000	390	490	210	6	M16	12	M45	960	2230	2325	48	60	48	1405.0

NOTES:

The above tables are guides to the most common sizes. Couplings to suit specific outside diameters not listed may be manufactured to order. Please contact us for further details.



Square Coupling

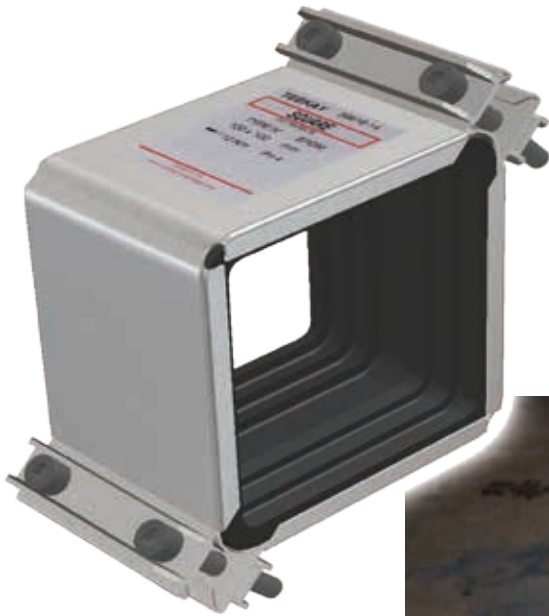

Teekay Square Couplings provide a comprehensive solution to joining box section without the need for hot working onsite. Available in 60 mm, 80 mm and 100 mm sizes, the square coupling lends itself to the joining of aeration pipes. Expansion and contraction can also be accommodated as the coupling is supplied as a non-anchoring type. High temperature gasket options are available.

Material Selection

Type IV

Casing: AISI 316L/ DIN 1.4404

Fasteners: AISI 316/ 316L

Gasket: EPDM/NBR/H-NBR/FKM/VMQ

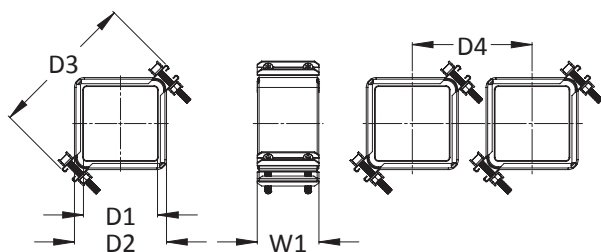

Sizes:

60 mm, 80 mm, 100 mm.

Gaskets:

EPDM -40°C to +100°C, NBR -20°C to +80°C, HNBR -20°C to +130°C, Viton -20°C to +250°C, Silicone -70°C to +270°C (depending on grade)

Pipe Materials:

Box section

D1 Size	D2 Coupling O.D.	Pipe O.D. Tolerance	D3 Coupling	D4 Minimum	W1 Width	Weight
(mm)	(mm)	(mm)	(mm)	(mm)	(mm)	(KG)
60	88	58.0 / 62.0	155	130	85	0.92
80	108	78.0 / 82.0	175	145	85	1.08
100	128	98.0 / 102.0	205	173	85	1.25

NOTES:

The above tables are guides to the most common sizes. Couplings to suit specific outside diameters not listed may be manufactured to order. Please contact us for further details.



Whilst the Teekay Pipe Coupling range is easy and simple to install and use onsite, it is necessary to take external forces and environments into account when carrying out any installations. The following pages outline these elements and offer general installation guidelines and principles for good piping practice. Detailed piping system design should only be undertaken by independent professionals or specialists.

Installation Guide

Pipe Materials

Teekay **Axilock** Pipe Couplings are primarily designed to join metallic pipes. Other pipe materials, such as rigid plastics and GRP, can also be joined under certain circumstances. Soft plastic materials, such as PE, must be fitted with internal stiffeners (these should be specifically requested at time of order) but will not resist pull out forces generated by cold creep. Please contact us prior to joining non-metallic pipe materials.

Teekay **Axiflex** Pipe Couplings are suitable for use with the following piping materials:

- Carbon Steel (seamless, longitudinally or spirally welded)
- Stainless Steel (seamless or longitudinally welded), metric thin wall or standard schedule sizes
- Cast or Ductile Iron
- Concrete
- Asbestos Cement
- Glass Reinforced Plastic (GRP)

- Fibre Reinforced Polyester (FRP) centrifugally cast or spirally wound
- PVC and uPVC
- High Density Polyethylene (HDPE) and MDPE
- Polybutylene, Polypropylene and ABS



Angular Misalignment

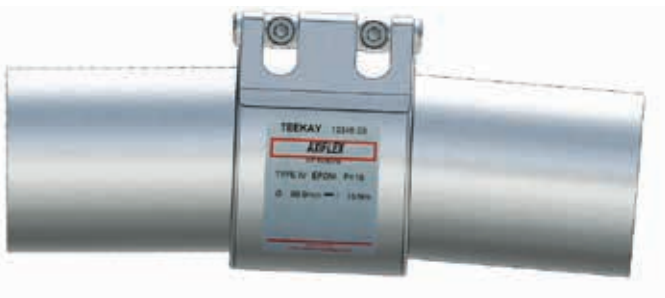

Maximum angle of deflection for **Axilock** Pipe Couplings:

Pipe Size O.D. (mm)	Maximum Angle of Deflection
21.3 – 60.3	5°
60.3 – 219.1	4°
219.1 – 406.4	2°
406.4 – 711.2	1°

Maximum angle of deflection for **Axiflex** Pipe Couplings:

Pipe Size ND (mm)	Coupling Width (mm)	Maximum Angle of Deflection
40 – 100	85	5°
80 – 300	110	5°
150 – 500	140	5°
600 – 700	140	3.5°
800 – 1200	140	2°
200 – 700	210	5°
800 – 1200	210	3°
1300 – 1800	210	2°
1900 – 3000	210	1°
200 – 800	310 / 410	5°
900 – 1300	310 / 410	3°
1400 – 2300	310 / 410	2°
2400 – 3000	310 / 410	1°

Please note: Maximum angle of deflection assumes that the coupling spans the angle evenly.

Allowable pipe diameter tolerances

Type of Teekay Coupling	Pipe Outside Diameter	Coupling Width	Outside Diameter Tolerance
	(mm)	(mm)	(mm)
Axilock-S Axilock Axilock-FP Axilock-FP Ultra	21.3 – 35.0	45	+ 0.3 / - 0.3
	38.0 – 57.0	65 / 85	+ 1 / - 1
	60.3 – 429.0	85 / 110	+ 2 / - 1
	429.0 – 711.0	110	+ 2 / - 1
Axiflex Stepped Repair Coupling	21.3 – 35.0	45	+ 0.3 / - 0.3
	38.0 – 44.5	65	+ / - 1
	48.3 – 76.1	85	+ / - 1.5
	82.5 – 125.0	85	+ / - 2
	88.9 – 149.9	110	+ / - 2
	153.0 – 193.7	110	+ / - 2.5
	200.0 – 326.0	110	+ / - 3
	153.0 – 193.7	140 L	+ / - 2.5
	200.0 – 635.0	140 L	+ / - 3
	168.3 – 170.0	140	+ / - 2.5
	291.1 – 345.4	140	+ / - 4
	355.0 – 1255.0	140	+ / - 4
	219.1 – 345.4	210	+ / - 4
	355.0 – 1255.0	210	+ / - 4
	1256.0 – 2350.0	210	+ / - 8
	2351.0 – 3050.0	210	+ / - 16
	315.0 – 326.0	310 / 410	+ / - 4
	333.8 – 1255.0	310 / 410	+ / - 4
	1256.0 – 1631.0	310 / 410	+ / - 8
	1632.0 – 2350.0	310 / 410	+ / - 16
2351.0 – 3050.0	310 / 410	+ / - 16	

Distance between Pipe Ends

For Axilock-S, Axilock, Axilock-FP and Axilock-FP Ultra couplings the optimum distance between pipe ends is 0 - 8 mm. This allows for expansion and contraction, suction and vacuum, pipe deflection and a reasonable cutting tolerance.

For Axiflex, Stepped and Repair couplings the recommended gap between pipe ends depends on the width of the coupling and whether or not a vacuum ring is fitted. When the gap is exceeded (or in all vacuum applications) a vacuum insert must be fitted. The table gives the maximum pipe gaps for these couplings:

Coupling Width	Maximum Pipe Gap (without vacuum ring)	Maximum Pipe Gap (with vacuum ring)
(mm)	(mm)	(mm)
85	5	20
110	5	30
140	10	40
210	20	50
310	30	110
410	30	150

- maximum pipe gap without a vacuum ring can be doubled on applications where intrusion of the rubber gasket into the pipe gap is not a problem.
- maximum pipe gap with a vacuum ring is limited by the maximum angle of deflection. If the angle of deflection is less than the maximum allowable angle of deflection, the maximum pipe gap (with vacuum ring) can be increased accordingly.

Installation Guide

Teekay **Axilock** pipe couplings can accommodate up to 6 mm expansion/contraction in a straight line. At changes in direction make sure that any resultant angular deflection is restricted to a maximum of 2°.

Teekay **Axiflex** couplings can accept thermal expansion or contraction of the pipeline by axial movement through the coupling or by the angulation of two couplings. In either case the pipeline should be adequately restrained. If it is not possible to place the intermediate anchors between the couplings, the Teekay **Axiflex** coupling can be supplied with an integral central register to locate the coupling.

The recommended maximum pipe axial expansion or contraction which can be accepted by one coupling is as follows:

Coupling Width	Pipe Expansion / Contraction
(mm)	(mm)
85	2.5
110	7.5
140	14.5
210	25
310	35
410	35

Support & Restraint

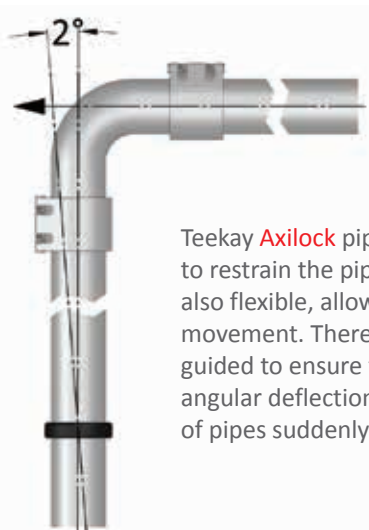

Teekay **Axilock** pipe couplings are designed to restrain the pipes axially. However, they are also flexible, allowing some axial and angular movement. Therefore the pipes should be guided to ensure that they remain within 2° angular deflection, especially where a long run of pipes suddenly changes direction.



Buried pipelines can generally be restrained by means of thrust blocks at major changes in direction. Straight runs and minor curves are usually restrained by soil friction. The same is largely true of gravity or very low pressure pipelines running along the ground, although with certain thermoplastic piping materials special attention should be given to restraining the forces generated by excessive expansion, contraction and creep.

For above ground applications pipelines should be anchored:

Intermediate anchors should be designed to withstand the forces and movements transferred and imposed upon them by each of the pipe sections to which they are attached, taking into account such forces as friction, wind load, self weight, and changes in fluid momentum.

Above ground pipelines subject to side thrusts, or required to be used to absorb angular deflections or lateral displacements, must be adequately restrained and supported.

Supporting of the pipeline for shear deadweight must be carried out to ensure that no excessive sagging occurs beyond the limits of angular deflection of the coupling. Support pitching will depend on pipe material, diameter, wall thickness and operating temperature.

A simple method of harnessing pipelines is by welding lugs to the pipe and connecting them with tie rods.

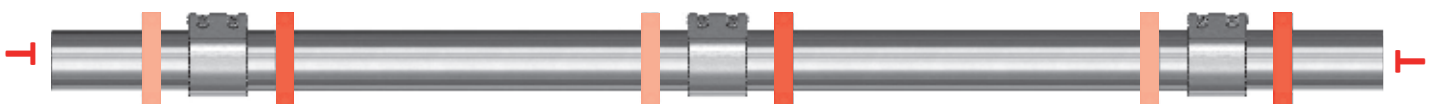

Shock, vibration, water hammers

Due to the design of the gasket, Teekay couplings dampen sound, vibration and water hammer. Shock levels to military requirements can also be accommodated. In the case of Teekay Axiflex couplings for applications where excessive vibration might occur, the couplings can be supplied with central registers to locate the pipe coupling in position.

Electrical Conductivity

In Teekay Axilock pipe couplings electrical conductivity is conveyed through the coupling casing by the anchor rings. In Teekay Axiflex pipe couplings stainless steel continuity clips are fitted to prevent the build-up of static electricity. These should be specifically requested at time of order.



Central Register

For above ground applications where there is a possibility that the coupling may move along the pipe due to excessive vibration, expansion and contraction etc. the Teekay Axiflex Pipe Coupling can be supplied with a central register. The central register is a circumferential ridge integral to the gasket and serves to locate the coupling on the pipeline, thereby preventing its movement. (This should be specifically requested at time of order).



Bracketed Couplings

Teekay Bracketed Pipe Couplings can be provided with brackets of various designs welded to the coupling casing which can then be bolted to any convenient support.



Installation Kit

The following are available to purchase separately or as a complete kit:



Pipe lubricant for easier installation of large diameter couplings



Speed brace for taking up the slack on the fasteners prior to tightening the coupling with a torque wrench



Socket adaptors



Soft mallets (to ensure good seating on large diameter couplings)



Torque wrenches

Installation Guide

Please check the following before installation to ensure that your Teekay pipe coupling works perfectly.

1. Handling of Teekay Couplings

- Do not drop the coupling.
- Keep the coupling clean – leave it in its packaging until you are ready to use it.
- Do not dismantle the coupling.
- Check that anchor rings are present on both sides if you are using axially resistant couplings (Axilock) and if you have requested a vacuum ring, please check that it is in place.
- The screws are coated – do not apply additional lubricants!

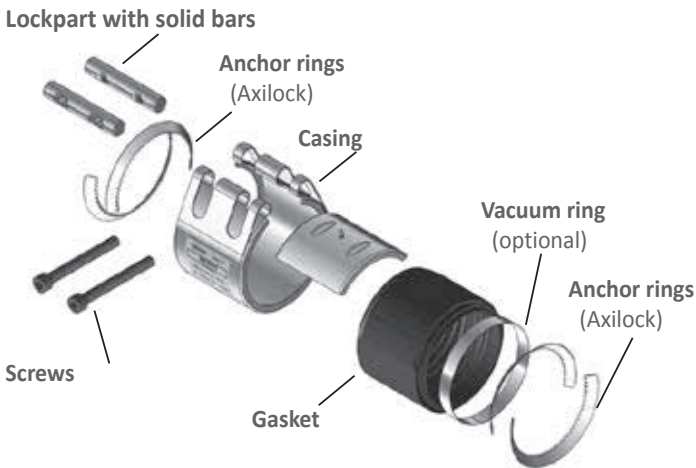

2. Pipe Lines

Pipe offset

- Make sure that the pipes are straight. The maximum acceptable pipe offset is 3 mm or 1% of the pipe diameter, whichever is smaller.

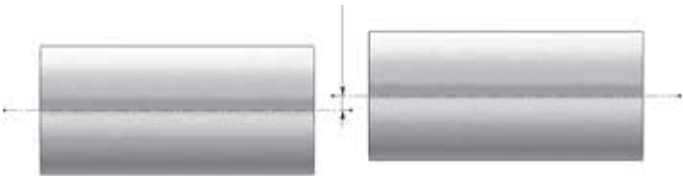

Test Pressure

Water is used as the testing medium for Teekay coupling pressure tests. Test pressure = 1.5 x wp. To find out about the pressure resistance when other media are used, please contact us.

Angular Deflection

- Maximum angulation for **Axilock Couplings**

Pipe O.D. (mm)	Max. angulation
21,3 – 60,3	5°
60,3 – 219,1	4°
219,1 – 406,4	2°
406,4 – 711,2	1°

- Maximum angulation for **Axiflex Couplings**

Nominal pipe size (mm)	Coupling with (mm)	Max. angulation
40 – 100	85	5°
80 – 300	110	5°
150 – 500	140	5°
600 – 700	140	3.5°
800 – 1200	140	2°
200 – 700	210	5°
800 – 1200	210	3°

See brochure page 36 for other widths.



Lateral Displacement

- Lateral displacement may be accommodated by the use of two Teekay Couplings with an intermediate length of pipe.



Expansion

- Axilock couplings can accommodate up to 6 mm of expansion, in a straight Line.



- At changes of direction, any resultant **angulation must not exceed 2°**.



For Axiflex see brochure page 38.

Ovality

- Teekay Axiflex pipe couplings are sufficiently flexible to accept a misshape within the pipe cross section provided the out-of-roundness is fairly evenly distributed around the circumference (oval rather than D shaped). **Depending on application and pipe material, up to 8% ovality may be accommodated.**

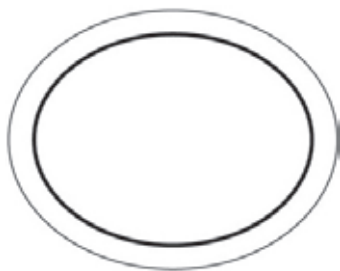

Installation

Do not exceed the limits listed in Section 2 and do not add them up. They refer to the static load on radially stiff pipes.

A safety factor must be included for dynamic loads such as water hammer, shear forces, etc. (please contact us for information).

3. Installation Examples

For information, please go to Page 44.

Please observe the following instructions prior to, during and after the installation of the coupling.

1. Prior to Installation

- The pipe ends should be cut square and all sharp edges and burrs must be removed.
- The pipe surface must be clean and smooth with no loose material in the region of the sealing lips.

- The optimum **distance between the pipe ends for Axilock couplings is max. 8 mm**.

- Measure half the width of the coupling and deduct 2.5 mm. Mark the pipe ends using this dimension. This will ensure that the pipe ends will not obstruct each other and that the coupling will sit centrally over the pipe ends after installation.

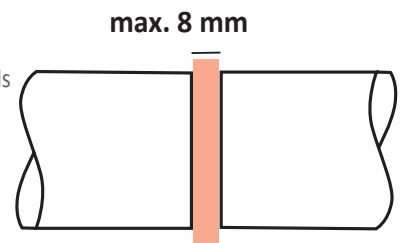

- If you are working with Axiflex couplings, the distance between the pipe ends will depend on the coupling width and **the use of a vacuum ring**. See brochure page 37.

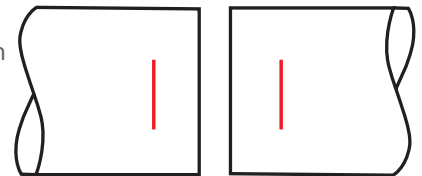

2. Installation of the Coupling

- Slide the coupling over the pipe and align it with the markings on the pipe ends. Tighten the pipe supports before tightening the coupling. Check that the pipes are not misaligned or angulated.

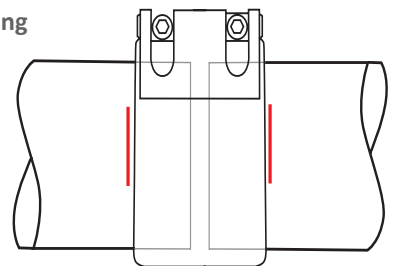

- Using a torque wrench, tighten the screws evenly, alternating from screw to screw until both "click off". **Make sure you comply with the required torque.** (See information on the label, description on Page 45.)



- See Section 4 (After Installation).

Installation Guide

Repair Coupling

Suitable also for permanent use.

3. Repair Coupling Installation

(Axiflex couplings that can be opened and wrapped around the pipe)

- Loosen the coupling screws.
- Place the opened coupling around the pipe.



- Insert the loose end of the gasket into the "tongue" located on the other side of the coupling.



- Make sure that the two ends of the gasket are flush against each other.

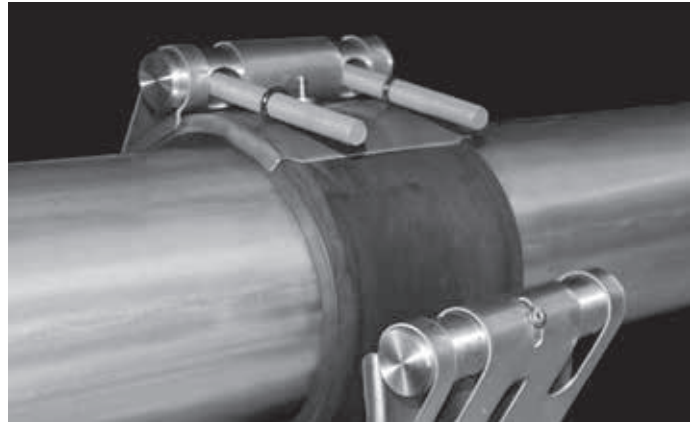

- Using a torque wrench, tighten the screws evenly, alternating from screw to screw until **both** "click off". **Make sure you comply with the required torque.** (See information on the label, description on Page 45.)
- For Axiflex, Repair- & Stepped Couplings > 600 mm lubricate pipe ends prior to installation.
- Use a soft mallet on the casing during tightening to ensure uniform gasket compression.



4. After Installation

- Check that the lockpart is parallel.

Torque

The couplings do not require any maintenance and must not be retightened once the torque has been reached. We recommend you mark the coupling once the screws have been torqued up. This will ensure that you and others know that the screws have been tightened.

If you are unsure as to whether the screws have already been tightened, loosen the screws completely and repeat the installation from scratch.

Please observe the following instructions prior to, during and after the dismantling of the coupling.

1. Prior to Dismantling

- Ensure that there is no pressure in the pipes at the joint to be removed.



- Protect yourself and equipment from spilling liquid.
- Make sure the pipe coupling is not supporting the pipe ends.

2. Dismantling the Coupling

- Loosen the screws evenly by alternating between them but do not remove completely.

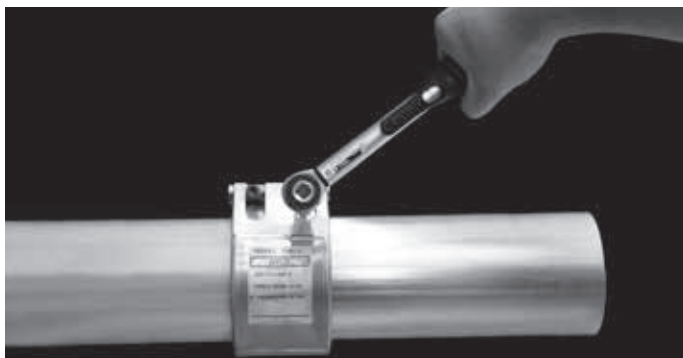

- Do not rotate the pipe coupling on the pipe as long as the anchor teeth are engaged (Axilock only).

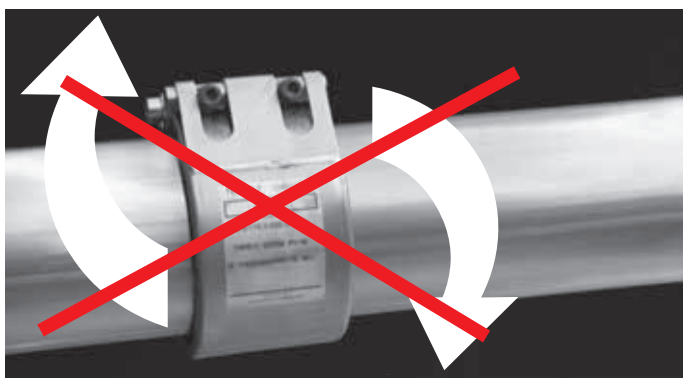

Removal of the coupling

Slide the coupling off the pipe cautiously. Make sure that the gasket sealing lips are not damaged in the process.

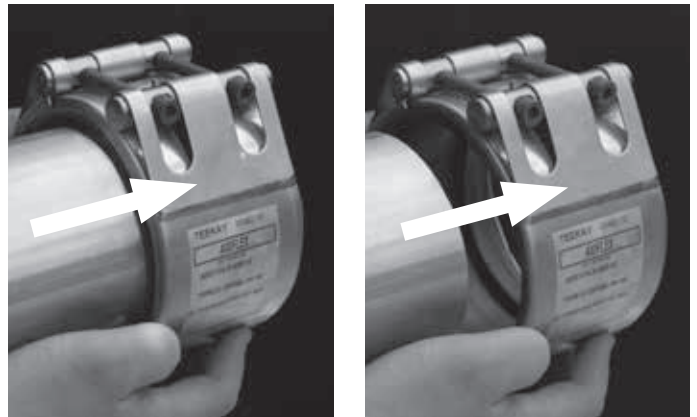

- Clean the coupling.



Condition of the seal

If the end seal of the Axilock coupling is partially severed, you can reinsert it.

(The purpose of the end seal is to protect the anchor ring.)



Installation Guide

Guidelines for pressurised systems (side view)

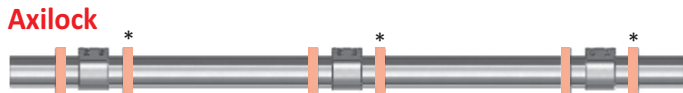

Axiflex pipe couplings are not designed to accept end load pressures. As a result, pipes must generally be anchored against internal pressure at changes in direction, branches, valves and at pipe ends and secured by fixed points and guides.

Shear force

Teekay pipe couplings should not be subjected to excessive shear force. The pipes should be fixed and supported.

Shear Force see Lateral Displacement (Page 40).

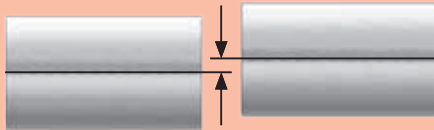

Loose guides

general

* optional

Has to be capable of accommodating the weight of the pipe including its contents e.g. a saddle or pipe support

Fixed point

Must absorb axial forces, e.g. anchored pipe clamp



Straight underground pipelines

Straight underground pipelines are usually restrained by soil friction. Changes of direction have to be controlled by means of thrust blocks.

T Thrust block

Its purpose is to prevent pipe movement, e.g. puddle flange, wall penetration or concrete block.

Axilock

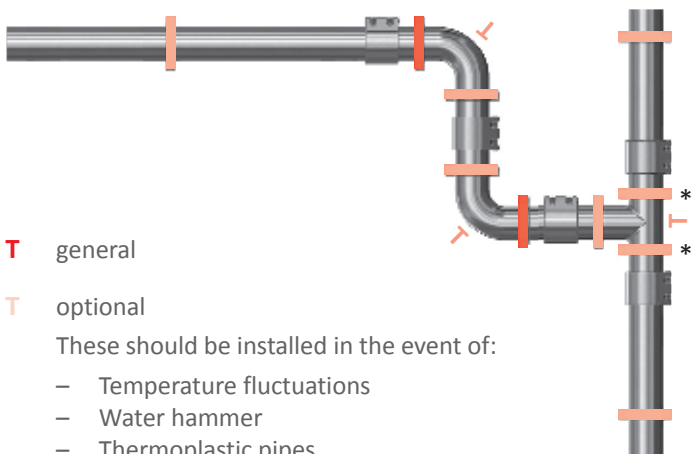

T general

T optional

These should be installed in the event of:

- Temperature fluctuations
- Water hammer
- Thermoplastic pipes
- Stainless steel pipes
- Long pipe runs
- Heavy wall thickness pipes

Axiflex

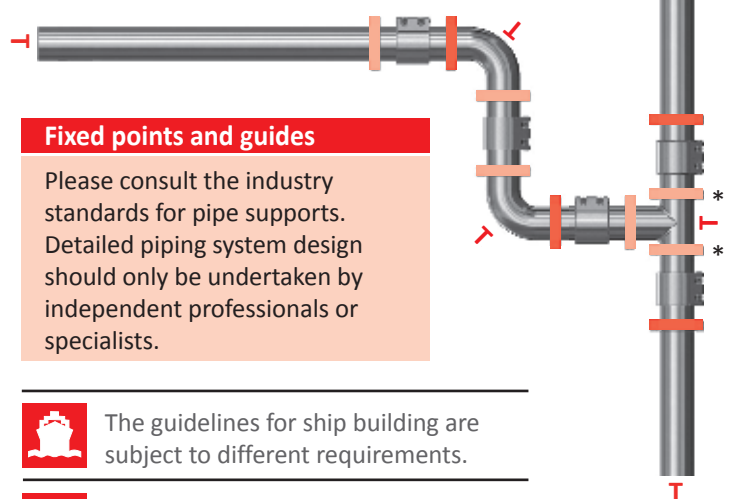

Fixed points and guides

Please consult the industry standards for pipe supports. Detailed piping system design should only be undertaken by independent professionals or specialists.



The guidelines for ship building are subject to different requirements.



If you have questions regarding coupling installation, please contact us.

Product Description and Label Details

Teekay-Axilock

(axially restrained)

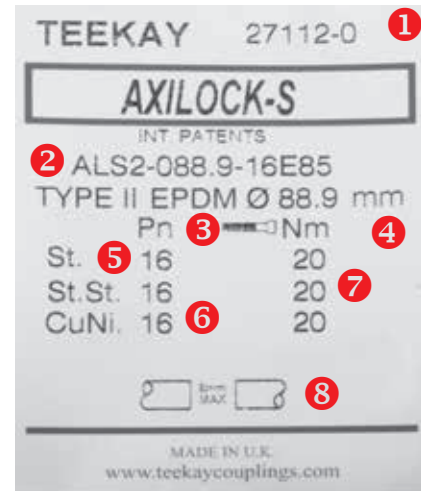
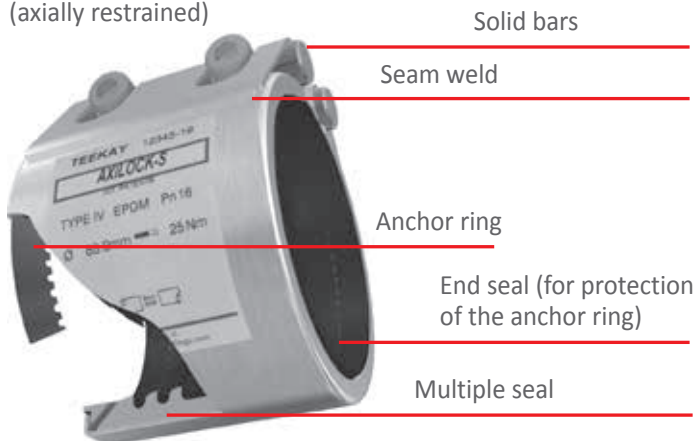

Teekay-Axiflex

(non axially restrained)

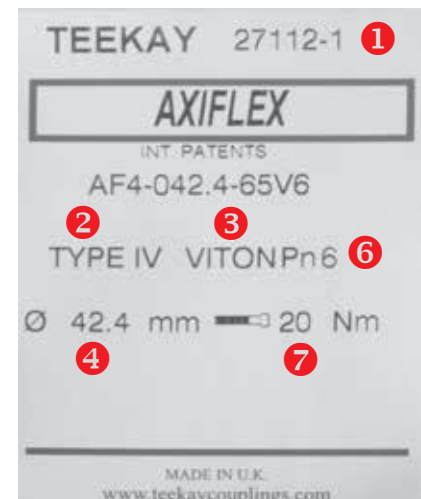
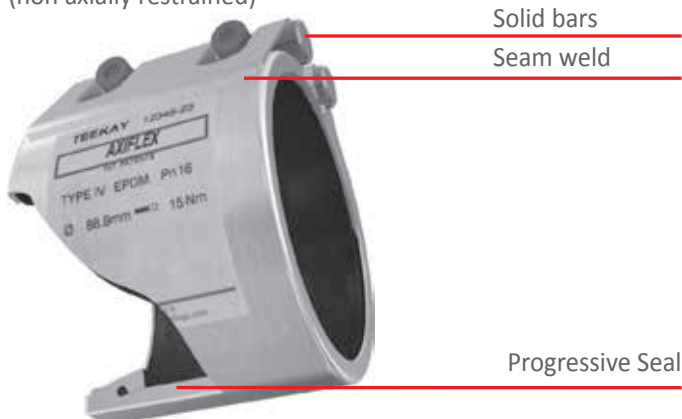

1 Traceability number

Please advise when requesting documentation retrospectively.

2 Description of the material

Type I = Casing 304 stainless steel
Lockpart alloy steel coated

Type II = Casing 304 stainless steel
Lockpart 316 stainless steel

Type IV = Casing 316L stainless steel
Lockpart 316 stainless steel

3 Gasket material

EPDM = - 40 °C to + 100 °C

NBR = - 20 °C to + 80 °C

HNBR = - 20 °C to + 130 °C

Viton = - 20 °C to + 250 °C

Silicone = - 70 °C to + 270 °C (depending on grade)

4 Pipe outside diameter

5 Pipe material

St = Carbon Steel

St.St. = Stainless steel

CuNi. = Copper nickel

6 Operating pressure – Axilock range

The operating pressure indicated applies to standard wall carbon steel pipes.
For use on thin or soft pipe materials such as thin wall stainless, copper alloy or plastic (by way of example only) please check with us first.

7 Tightening torque for screws

See Page 42 (Torque)

8 Maximum pipe gap

See Page 41 (Prior to Installation)

Build Quality

There are many different types of pipe couplings and pipe connections on the market; stainless steel couplings, cast iron couplings, push-fit couplings, grooved couplings.....

At Teekay we consider build quality to be one of the most important aspects of manufacturing a well-engineered and user-friendly product. We know that good build quality hugely improves the life and performance of the product. Listed below are some features which make the Teekay product range stand out from the rest:

TIG welded seam

When fastening the coupling, the section of the casing that has to withstand the most stress is the area where the "ear" is welded to the outer casing. We TIG weld this section with a strong seam weld and then passivate it so there is no chance of corrosion when exposed to the elements. The seam weld provides uniform strength across the whole width of the casing, ensuring the strongest possible connection. We never spot weld this area of the coupling.



Solid bars and 2 screws on each coupling

Teekay couplings come with solid bars which are spot-faced in order to reduce stress points on the screw head. The solid bar prevents corrosion of the screw thread and provides extra strength in the lockpart. All Teekay couplings are supplied with a minimum of 2 screws. This design feature is crucial to the secure fastening of the coupling across its entire width. The coating on each screw is a dry lubricant which negates the need for greasing the lockpart.



Unique Axilock multi-seal gasket

All Teekay Axilock-S, Axilock, Axilock-FP and Axilock-FP Ultra couplings come with a unique multi-seal gasket design which provides greater sealing security when compared with a single seal design. There is a high volume of material-to-space ratio which ensures long term sealing efficiencies.



1 - multi-seal gasket
2 - encapsulated anchor ring

Encapsulated anchor rings

All Teekay Axilock-S, Axilock, Axilock-FP and Axilock-FP Ultra couplings come with patented encapsulated anchor rings. This small section of rubber massively increases the life of the coupling by preventing any possible corrosion of the anchor rings. The teeth in the rings bite through the rubber and lock the pipes in place, leaving none of the teeth exposed when the coupling is installed. The rubber seal over the anchor ring also protects users when handling the coupling.



STANDARD CONTRACT CONDITIONS

1 INTRODUCTION 1.1 In these conditions save where the context otherwise expressly provides "the Company" shall mean Teekay Couplings Ltd of the address shown on the reverse side hereof as defined by section 154 of the Companies Act 1948 and "the Customer" shall mean the person, firm or company to whom the Company is to supply the goods or services specified as aforesaid as the case may be.

1.2 The contract and the terms and conditions thereof shall be construed according to the laws of England and the Courts of England alone shall have jurisdiction in relation to any matter arising out of the same.

1.3 These conditions shall apply to this contract except in so far as may be expressly agreed in writing by the Company and the Customer and any variation to this contract or to these conditions shall be binding only if confirmed in writing by the Company and the Customer. Except in so far as they may be consistent with these conditions and or are expressly confirmed in writing by the Company any conditions attaching to the order placed by the Customer shall not be of any effect.

1.4 No order from the Customer shall be binding until accepted by the Company in writing. The acceptance by the Customer of any quotation implies these terms and conditions, no departure from these being valid unless confirmed by the Company in writing. Any stipulation or condition in the Customer's order form which conflicts with any of these terms or conditions or in any way qualifies or negatives the same shall be deemed to be inapplicable to any order placed with the Company unless expressly agreed by the Company in writing. Goods from stock are offered subject to being unsold upon receipt of order, and any clerical error found in a quotation is subject to correction.

2 VARIATIONS, EXTRAS OR OMISSIONS The contract price shall be subject to revisions to take into account the cost of any variations, extras or omissions to or from this contract. Such alterations must be confirmed to and accepted by the Company in writing and their aggregate value shall not exceed 20 per cent of the contract price.

3 PRICES

3.1 Unless expressly stated to the contrary in this contract the contract price is based on the cost of material, labour and transport ruling at the date of the quotation or the date of this contract as the case may be.

3.2 If between the date and the termination of the work variations either by rise or fall occur in these costs the Customer will be notified in writing and the contract price shall be amended to provide for these variations. Any quotation is based on the rates of pay and conditions of employment subsisting at the date of the quotation which relate to the General Engineering Industry as defined by the agreements entered into by the various Engineering Unions with the Engineering Employers' Federation of which the Company is a member. Any amendments to those rates or conditions after that date whether National or Local shall be taken as an amendment to this contract.

3.3 Should overtime be worked at the request of the Customer or another on his behalf the additional cost shall be charged at the then current rates as an extra.

Any value added or other tax payable in respect of the manufacture, sale or supply of any goods or services to be provided by the Company under this contract shall be payable by the Customer in addition to the contract price except in so far as the same are expressly excluded.

4 COMPLETION The Company will use its best endeavours to keep to the dates specified for delivery or the completion of the contract works as the case may be. Should completion be hindered or delayed by extensions to the contract, deviations from the specification or any act or default on the part of the Customer or any case whatsoever, beyond the Company's direct control, and whether such delay or impediment occurs before or after the time or extended time for completion, the Company shall be allowed (without becoming liable for any payment to or claim by the Customer whether for compensation or otherwise) such extension of time, either prospectively or retrospectively as may be reasonable and any such extension shall exonerate the Company from all liability in respect of such delay and the Customer shall not be enabled to rescind the contract by reason of any such delay.

5 QUALITY OF WORKMANSHIP Every effort will be made to ensure sound material and good workmanship but the Company gives no warranty, express or implied of material, workmanship or fitness of goods for any particular purpose whether such purpose is known to the Company or not. If any material or workmanship proves defective, and the Customer shall notify the Company in writing of the alleged defect within 12 months of completion of this contract (time being of the essence) the Company will repair or replace at their option such material free of charge, at their Works, on the terms of this contract but so that the liability of the Company in respect of or consequent upon any such defect whether in original or replaced material shall not extend to any other damage suffered by the Customer or any third party whether by way of consequential damages or loss of profit or otherwise.

6 DRAWINGS, etc. The Company shall not be responsible for any defect, damage or loss caused directly or indirectly, inaccuracy, error or omission in any Drawings, Bills of Quantities, Specifications, patterns or templates or other materials supplied by the Customer or on his behalf.

7 GENERAL LIABILITY The Company shall not be liable for any loss or damage occurring other than directly incurred through a breach of one or more of its obligations under this Contract and without prejudice to the generality of the foregoing the Company shall not be liable for any loss of profit, damage to plant or machinery or extra expenditure or any consequential or special loss suffered by the Customer or by any third party.

8 TERMINATION The Company shall be entitled without prejudice to its other rights whether under this contract or under the general law to terminate this contract or to suspend further deliveries in any of the following events:

8.1 If the Customer has not paid any debt due and payable after written demand has been made for payment thereof or if the Customer shall fail to provide any letter of credit, bill of exchange, guarantee or other security required by this contract.

8.2 If the Customer shall fail to take delivery of any goods under this contract otherwise in accordance with the Customer's contractual rights.

8.3 If any event mentioned in sub paragraph 11(6) of these conditions shall occur.

8.4 If the Customer is in breach of this contract.

And in the event of the Company electing to suspend delivery under this condition it shall be entitled as a condition of resuming delivery to impose such conditions as to payment and or as to the provision of security for payment as it shall in its discretion decide.

9 RISK Unless otherwise specifically provided the risk in the goods shall pass to the Customer when the goods are put on rail, road, transport, ship or aircraft, or in the case of goods collected from the Company's works, when the goods are loaded on to the vehicle of the Customer or his carrier or other agent. The risk in goods which under this contract are to be delivered by the Company in its own transport shall pass at the time of unloading of the goods at the Customer's works or at such other places as the Customer may have specified.

10 DELIVERY The goods shall be deemed to have been delivered to the Customer at the moment of passing of the risk as mentioned in paragraph 9 above.

11 TITLE Until full payment for the goods have been received by the Company:

11.1 the property in the goods shall remain in the Company.

11.2 should the goods (or any of them) be converted into a new product, whether or not such conversion involves the admixture of any other goods or thing whatsoever and in whatever proportions the conversion shall be deemed to have been affected on behalf of the Company and the Company shall have the full legal and beneficial ownership of the new product.

11.3 the Customer shall keep and store the goods and the new products referred to in (2) above in such a manner that they can be identified as being the property of the Company.

11.4 subject to (5) and (6) below, the Customer shall be at liberty to sell the goods and the new products referred to in (2) above in the ordinary course of business on the basis that the proceeds of sale shall be the property of the Company and held in trust by the Customer for the Company absolutely.

11.5 the Company may at any time revoke the Customer's power of sale by notice to the Customer if the Customer is in default for longer than seven days in the payment of any sum whatsoever due to the Company whether under this contract or otherwise or if the Company has bona fide doubts as to the solvency of the Customer.

11.6 the Customer's power of sale shall automatically cease if a receiver is appointed over any of the assets or the undertakings of the Customer or a winding-up order is made against the Customer or the Customer goes into voluntary liquidation or calls a meeting of or makes any arrangement or composition with creditors or commits any act of bankruptcy.

11.7 upon determination of the Customer's power of sale under (5) or (6) above the Customer shall place the goods and the new products at the disposal of the Company who shall be entitled to enter upon any premises of the Customer for the purpose of removing the goods and new products from the premises (including severance from the realty where necessary).

12 LOSS OR DAMAGE IN TRANSIT No claim will be entertained for loss or damage to goods in transit except where the goods are sent Carriage Paid under the conditions of this contract and both the carriers and the Customer receive written notification of such loss or damage within THREE days of receipt of the goods by the Customer.

13 INSPECTION No special test or inspection of the goods shall be required by the Customer unless expressly agreed in writing in the contract and any such test or inspection shall be carried out at the Customer's expense and so as not to delay delivery of the goods.

If the Customer does not test or inspect the goods within 14 days after being given written notice that the goods are available for testing or inspection or if the Customer does not within seven days after any such testing or inspection give in writing to the Company full details of any alleged deficiency in the goods then the Customer shall be deemed to have accepted the goods as being in conformity with this contract and shall not be entitled to reject the goods on any ground which ought to have been disclosed upon such test or inspection.

14 STORAGE If forwarding instructions are not received within 14 days of the Company giving written notice to the Customer that the goods are ready for despatch the Customer shall pay in addition to the price of the goods a reasonable additional charge for storage and insurance (without any liability on the part of the Company to provide or for failure to provide such storage or insurance of for the manner in which the same are provided) and the Customer shall pay for the goods as if they had been despatched.

15 PAYMENT The Customer shall pay net cash for the goods by the 1st day of the month following the month of despatch of the goods (or in the event of the failure of the Customer to give forwarding instructions the date of which the Company gives written notice to the Customer that the goods are ready for despatch) and in the event of failure to make payment on that date the Customer shall also pay interest on the price of the goods at the rate of 3% per annum over the Base Rate for the time being of National Westminster Bank Limited until payment as well after as before any judgement or order recovered hereunder or any other special agreed payment terms.

16 WAIVER The rights of the company and the Customer hereunder shall not be affected or prejudiced by any waiver or forbearance afforded by the one to the other in respect of the performance of the terms of this contract and except as expressly stated in writing the rights of each of them shall remain in full force and effect notwithstanding any such waiver or forbearance.

17 ASSIGNMENT The rights and obligations of each party under this contract shall not be assignable by that party except with the written consent of the other party

WARRANTY

Each Teekay Pipe Coupling is warranted to be free from manufacturing defects and will be repaired or replaced without charge if failure occurs within one year after date of shipment providing it has been used as recommended and in accordance with recognised piping practice, and providing it has not been worn out due to severe operating service, such as is encountered under extremely corrosive or abrasive conditions. Teekay Couplings Limited makes no other warranty, either express or implied. Our liability is limited to our sale price of the particular product. In no event shall Teekay Couplings Limited be liable for any consequential damages.

Product presentations including dimensions, designs and specifications appearing in this catalogue are representations of product availability at time of publication only. Actual geometry, dimensions and designs are subject to design and manufacturing changes without notice.

Copyright in all Teekay® Publications is strictly reserved, absolutely no material therein may be reproduced, stored in a retrieval system or transmitted in any form or by any means, electronic, mechanical, photocopying, recording or otherwise without written consent of the Taylor Kerr Group.

The contents of this brochure give general information about the products we make. It is not intended to be a piping system design manual. Piping system design should only be undertaken by independent professionals or specialists.

Although we make reasonable efforts to update the information in our brochures, we make no representations warranties or guarantees, whether express or implied, that the content of this brochure is the most accurate, complete or up-to-date version and consequently to the fullest extent permitted by law errors and omissions are accepted.

This brochure was originally written in the English language and, in the event of any conflict inconsistency or discrepancy between the English language version and any translation, the English language version shall apply.

INTERNATIONAL PATENTS AND TRADEMARKS



Teekay Couplings Ltd.
Disraeli House
12 Aylesbury End
Old Beaconsfield
Buckinghamshire
HP9 1LW
England

Phone: +44 (0) 1494 679500 Fax: +44 (0) 1494 679505
email: info@teekaycouplings.com

Registered in England and Wales. Company Number: 03538232
Registered address: 4 Claridge Court, Lower Kings Road, Berkhamsted, Hertfordshire, HP4 2AF.

 www.teekaycouplings.com